

**FOCAL
POINT
FIRES** plc

Reflection

Fuel Effect Gas Fire

INSTALLATION, SERVICING AND USER INSTRUCTIONS

All instructions must be handed to the user for safekeeping

Revision A 10/03

Country(s) of destination: GB, IE

Focal Point Fires plc, Avon Trading Park, Christchurch, Dorset BH23 2BT

☎: (01202) 499330

Fax: (01202) 499326

www.focalpointfires.co.uk

e-mail: sales@focalpointfires.co.uk



INSTALLATION INSTRUCTIONS

Preliminary Notes Before Installation

This appliance is an inset live fuel effect gas fire that provides radiant warmth.

The fire is designed to fit into a purpose made builder's opening, and use natural draught flues as listed in the Installation Requirements.

The appliance must be installed by a competent person in accordance with Gas Safety (Installation and Use) Regulations 1998. It is strongly recommended that a CORGI registered engineer be used for this purpose.

Read all these instructions before commencing installation.

This appliance must be installed in accordance with the rules in force and only used in a sufficiently ventilated space.

This appliance is factory set for operation on the gas type, and at the pressure stated on the appliance data plate.

<i>Section</i>	<i>Contents</i>	<i>Page No.</i>	<i>Section</i>	<i>Contents</i>	<i>Page No.</i>
1.0	Important Notes	1	9.0	Preparing the Opening	5
2.0	Appliance Data	2	10.0	Gas Supply	6
3.0	Installation Requirements	2	11.0	Fitting the Firebox	6
4.0	Site Requirements	3	11.1	Cable Fixing	6
5.0	Ventilation	3	11.2	Gas Connection	7
6.0	Unpacking the Appliance	4	12.0	Fuel Bed Layout	7
7.0	Component Checklist	4	13.0	Fitting the frame	7
8.0	Preparing the Appliance	4	14.0	Testing & Commissioning	7
			15.0	Servicing	9
			16.0	Troubleshooting Guide	11

1.0 IMPORTANT NOTES

This fire is an inset live fuel effect gas fire providing radiant warmth. It is designed to operate on natural gas only.

It is the LAW that all gas appliances and fittings are installed by a competent person (such as a CORGI registered fitter) and in accordance with the Gas Safety (Installation and Use) Regulations 1998, the relevant British Standards for Installation, Codes of Practice and in accordance with the Manufacturers' Instructions. The installation shall also be carried out in accordance with the following regulations:

The Building Regulations issued by the Department of the Environment, the Building Standards (Scotland) (Consolidation) Regulations issued by the Scottish Development Department.

BS 5871 part 2

BS 5440 part 1

BS 8303

BS 1251

BS 6891

BS 6461 part 1

BS 5482 part 1

Note - For Republic of Ireland, reference should be made to the relevant standards governing installation, particularly in regard to flue sizing and ventilation. See IS813, ICP3, IS327 and any other rules in force.

Failure to comply with these regulations could lead to prosecution and deem the warranty invalid.

This appliance must be installed in accordance with the rules in force and used only in a sufficiently ventilated space.

Consult all instructions before installation and use of this appliance.

This appliance is free from any asbestos material. Refractories and fuel bed are constructed from ceramic fibre.

2.0

APPLIANCE DATA

Manual Control Versions

	<u>Log Version</u>	<u>Glass and Pebble Version</u>
Gas Group	G20 Natural Gas CAT I2H	G20 Natural Gas CAT I2H
Inlet Pressure	20 mbar	20 mbar
Max Energy Input (gross)	6.8 kW	6.8 kW
Min Energy Input (gross)	3.5 kW	4 kW
Pilot Energy Input (gross)	166 W	166 W
Setting Pressure - High (cold)	16.25 mbar (+/- 0.75mbar)	16.25mbar (+/- 0.75mbar)
Setting Pressure - High (hot)	16.5 mbar (+/- 0.75mbar)	16.25mbar (+/- 0.75mbar)
Setting Pressure - Low (hot)	5.5 mbar (+/- 0.5mbar)	6.5mbar (+/- 0.5mbar)
Main Injector Burner	Bray cat. 82/440	Bray cat. 82/440
Gas Inlet Connection	8mm compression	8mm compression
Ignition	Integral Piezo spark	Integral Piezo spark
Spark Gap	3.5 to 4.5mm	3.5 to 4.5mm
Weight	?? Kg	?? Kg

Please see Data Badge affixed to appliance for current data.

This appliance is for use only with the gas type, and at the pressure stated on the appliance Data Badge, and is for decorative purposes.

3.0

INSTALLATION REQUIREMENTS

This appliance **MUST NOT** be installed into a room containing a bath or shower, or where steam may be present. The fire has been designed to fit into a purpose made builders' opening meeting certain dimensional requirements.

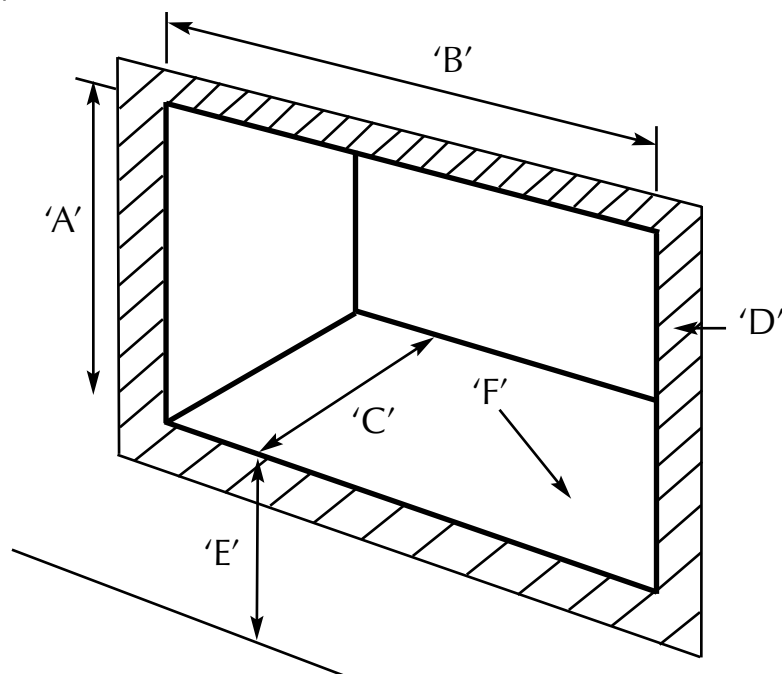

- A. Opening height: 615mm Min. / 710mm Max.
- B. Opening width: 785mm Min/865mm Max.
- C. Opening depth: 350 mm Min.
- D. This area must be flat and vertical to ensure a good seal.
- E. Height to hearth: 135mm Min.
- F. This area to be flat and level

The flue must have an effective height of at least three meters, as measured from the base of the opening to the top of the flue. Any flue damper plates or restrictors should be removed and no other restriction fitted to the flue. Where removal is not practical, the restriction must be fixed in the fully open position.

A natural draught flue system is required, and if previously used for solid fuel or oil burning, the flue and chimney must be swept prior to appliance installation. The flue must be checked before installation by using a smoke pellet or similar to ensure proper draw and that leakage is not evident at any joints. Repair and re-test as necessary before the appliance is installed.

4.0 SITE REQUIREMENTS

The fireplace opening should be inspected and repairs made where necessary. The flue must be connected to only one fireplace, and the flue must not vent more than one appliance (i.e. not shared with a gas back boiler). There must be no opening in the flue apart from the one that the appliance is installed into, and the one venting the gases into the air. A suitable terminal may be fitted, such as class GC1, as regulations allow.

The opening WIDTH and HEIGHT dimensions should be between 785mm and 865mm wide, and 615mm to 710mm high.

Opening DEPTH should be 350mm or greater. Opening DEPTHS include any plaster or infill panels which form part of the installation.

This appliance requires a natural draught flue system which may be one of the following;

225mm x 225mm (9in x 9in) brick or stone.

175mm (7in) minimum diameter lined brick or stone.

175mm (7in) minimum diameter twin wall flue conforming to BS 715.

Any existing under grate draught device must be sealed off.

The opening wall must be non-combustible and have adequate flat surface for appliance sealing.

The appliance must be fitted with a non-combustible hearth, the surface of which is at least 12mm thick with a minimum depth of 300mm and width of 1170mm. The top surface is at least 50mm above the surrounding floor level.

To enable the products of combustion to be cleared properly up the flue, the outlet on the top of the appliance must have a minimum 50mm clearance between it and the back wall of the opening or other obstruction. The area immediately above the outlet must form a smooth path into the flue.

A combustible shelf may be fixed to the wall above the fire, providing that it complies with the dimensions given below.

A non-combustible shelf may be fitted to within 30mm of the top edge of the fireframe.

Combustible materials, such as wood, may be fitted to within 100mm (4in) of either side of the frame of the appliance, providing the forward projection does not exceed 100mm (4in).

<i>Maximum depth of shelf</i>	<i>Minimum distance from base of firebox to underside of shelf</i>
100mm (4in)	860 mm (34 in)
150mm (6in)	970 mm (38 in)
203mm (8in)	1020 mm (40 in)

Any combustible side walls must be at least 500mm to the side of the radiant heat source.

As with all heating appliances, any decorations, soft furnishings, and wall coverings (i.e. flock, blown vinyl and embossed paper) positioned too close to the appliance may discolour or scorch.

5.0 VENTILATION

No purpose provided ventilation is normally required for this appliance. The requirements of other appliances operating in the same room or space must be taken into consideration when assessing ventilation.

If spillage is detected when commissioning the appliance then amongst other problems there may be insufficient natural ventilation for the correct operation of the flue. This is potentially a greater problem should the property be of modern nature. If the appliance does not spill with windows open but does with windows closed, this proves that lack of ventilation is the problem, if not, it will be the flue at fault. Installation of an air brick is the best

5.0 VENTILATION (continued)

solution. Any ventilation fitted must comply with BS 5871 part 2 and BS 5440 part 2.

Spillage detected during commissioning is almost always a result of poor flue performance, which cannot be corrected by any amount of ventilation.

For Republic of Ireland ventilation may be required, see IS 813, ICP3, IS 327, and any other rules in force.

6.0 UNPACKING THE APPLIANCE

Stand the carton the right way up, cut the strapping bands and remove the top end cap. Read all the instructions before continuing to unpack or install this appliance.

Remove the box containing the fireframe, the box containing the ceramic logs, and the box containing the burner unit. Remove the cardboard packing pieces, and any bags containing other fittings or parts.

When all loose parts have been removed, the outer sleeve may be lifted off to reveal the appliance. Check that the components supplied correlate with the checklist given in section 7.0.

Please dispose of the packaging materials at your local recycling centre.

7.0 COMPONENT CHECKLIST

<i>QUANTITY</i>	<i>DESCRIPTION</i>
1	Firebox assembly.
1	Burner unit assembly.
1	Decorative frame.
1	Moulded ceramic fibre log support (Log version only).
8	Individual large ceramic logs (Log version only).
6	Individual small ceramic logs (Log version only).
1	Bag of vermiculite (Log version only).
1	Bag of heat resistant glass crystals (glass fuel bed versions only)
10	Small individual ceramic pebbles (glass fuel bed models only)
1	Set of manufacturers instructions and warranty card.
1	Cable fixing kit comprising; 2 cables, 2 tensioners, 2 clamps, 4 fixing eyes, 4 fibre rawl plugs.
1	Self tapping screw pack.
4	Lengths of self adhesive sealing strip.
1	Rubber grommet.
1	Fitting kit comprising; 1 Inlet restrictor cock, 1 allen key, 2 cable ties.

8.0 PREPARING THE APPLIANCE

Note: Ensure that the gas supply is isolated before commencing installation of the appliance.

The fireplace opening and environment must be in compliance with the specifications laid down in the appropriate sections of these instructions. Remove the firebox and burner unit from their cartons and stand upon a dust sheet or similar. Place the frame, ceramic logs and fixings safely to one side.

Knockout holes are provided in the rear of the firebox for use where concealed pipework is required. Where necessary, knock out the appropriate hole with a sharp tap from a hammer, and fit the rubber grommet supplied. A small incision can now be made in the rubber to slip snugly around the outside of the pipe and sleeving. **Do not install or use the appliance without the seals in place.** If a hole is inadvertently opened, reseal with an intact grommet. Failure to fit the seal correctly will cause flue suction to act upon the area under the burner, resulting in poor performance and intermittent cutting out of the burner.

9.0 PREPARING THE OPENING

Before installing the fire, check the flue using a smoke pellet, if alterations to the flue or flue throat are necessary carry out this check after the work is done. All of the smoke should travel up the flue and exit correctly from the terminal. If problems are found, DO NOT fit the fire until corrective action is completed.

This appliance is designed to fit into a purpose-made builders opening. The opening WIDTH and HEIGHT dimensions should be between 785mm and 865mm wide, and 615mm to 710mm high. Opening DEPTH should be 350mm or greater. Opening DEPTHS include any plaster or infill panels which form part of the installation.

IMPORTANT :The structural integrity of the wall and flue/flue throat must be maintained. It is recommended that this stage of the installation be undertaken by a qualified builder.

Obtain a suitable lintel. We would suggest either a pre-cast concrete or steel lintel. Minimum bearing lengths - Generally lintels should be bedded the correct way up on the supporting bearings in the mortar. The recommended minimum bearing length for use in 3.5N/mm² blockwork is 100mm in openings up to 1000mm.

Fit the lintel, and remove brickwork as necessary in order to make an opening to the correct size. Brick up the old opening and base to the dorrect height. Ensure the base of the opening is level and flat.

Make good the front wall surface around the opening, ensuring that the surfaces are true, vertical and flat in order to ensure a good seal when the firebox is fitted. This front surface must be non-combustible and capable of withstanding 150°C.

Offer up the firebox to the opening to check the fit is good. Ensure that it slides in correctly, the sealing face sits flat and square to the wall or back panel, and that the base is firm on the openings base. At this stage it is essential to ensure that the spigot outlet of the fire is not restricted in any way.

Remove the firebox and take any necessary measurements before making good and preparing for final installation.

SCREW FIXING. For fixing by screw, mark and drill the fireframe or base, and the relevant points in the opening or on the wall. Rawlplugs will again be required. Pre-punched holes are not proided for this purpose to allow you to choose the optimum positions.

GAS SUPPLY. Following preparation for the fixing method, the concealed gas supply, where required, can now be put into place. Refer to the gas supply section for suggested pipe routes. The ends of the sleeving in which the gas pipe is run should be sealed. The ends of the 8mm supply pipe should be temporarily sealed to prevent the ingress of debris during fixing.

The non-combustible hearth unit should now be secured in place, which may be protected using surplus packing material during fitting.

CABLE FIXING. For fixing of the fire by the cable method, see the relevant section. The cable fixing locations should be marked on the back of the opening and the holes drilled. Fit the fibre rawlplugs and eyebolts to these holes. *Note: Plastic rawlplugs are NOT suitable for this application.*

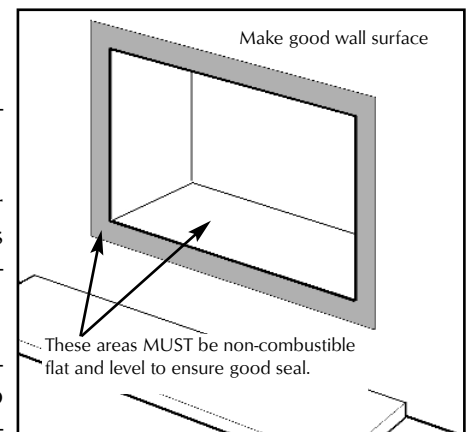
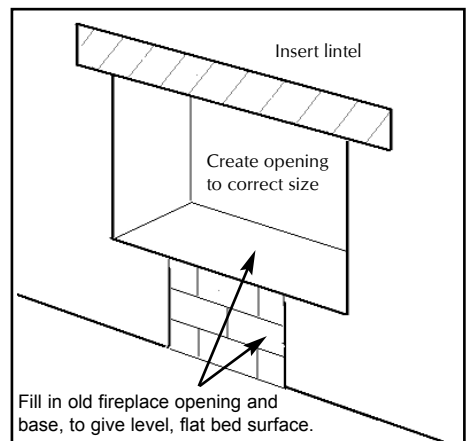
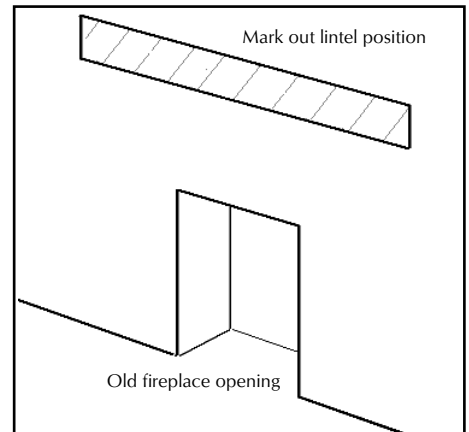

10.0 GAS SUPPLY ROUTING

When the opening is ready for installation of the fire, the gas supply can be routed. An in-line restrictor cock is supplied with the appliance. It is recommended that this be incorporated into the 8mm supply in an accessible position, for example, underneath the 'shelf' of the appliance.

A compression fitting is supplied in order that the 8mm supply pipe may be connected directly into the gas valve. A concealed connection may be made to the appliance by routing the supply pipe into the lower firebox via one of three knock-out holes. These are located in the sides and rear of the firebox.

The gas pipe must be suitably protected where it passes through fireplace openings. Any sleeving should be sealed to the pipe at its ends.

The open end of the supply pipe should be sealed temporarily during the installation of the firebox to prevent the ingress of dirt and dust.

11.0 FITTING THE FIREBOX

The firebox may be fitted to the opening by using screw fixing or by the cable kit as described in the relevant section. Leave the polythene coating in place until fitting procedures are complete to eliminate any risk of scratching the decorative stainless steel finish of the firebox.

To fit the firebox, firstly check the fire goes fully back into the opening.

Secure the fire box by drilling and screwing down the frame of the firebox, or use the cable fixing method.

11.1 INSTALLATION BY CABLE FIXING KIT

Drill the four holes for the rawl plugs, as shown in the diagram. If the fireplace configuration does not allow the exact layout given, the eyebolts should be positioned as close to the correct layout as possible.

Before finally fitting cables, apply the self adhesive sealing strips. The fireframe must be sealed evenly to the fireplace opening all around the periphery.

Thread the tensioning cables through the holes in the top of the firebox, then the eyelets, and finally through the lower holes in the back of the firebox.

Push the appliance back into to fireplace, centralise, and pull the loose tensioning cables through the holes into the firebox. . Thread the tensioner bolts onto the cables, with the nuts screwed down close to the tensioner head. Slide the screwed nipple onto the cable, pull cable tight, and tighten nipple.

The tension of the cable may now be adjusted by using a suitable spanner on the tensioner nuts to pull the appliance tightly against the fireplace opening. Visually inspect the seal and reseal if necessary.

Note: DO NOT cut off excess cable.

Surplus cable must not be cut off, as it will be impossible to refit the fire after servicing. Coil up the surplus cable, and locate under the shelf at the rear of the firebox. Two cable ties are provided so as the cable may be secured out of sight.

Note : If running a concealed gas supply, ensure grommets are secure around incoming pipes.

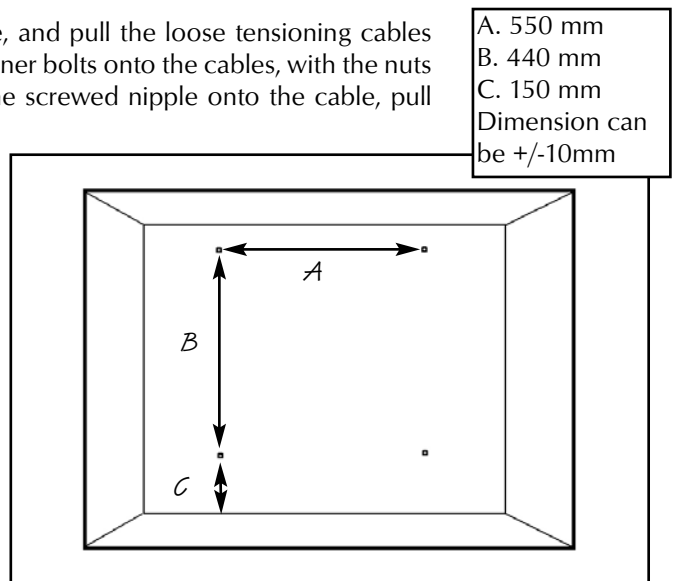

11.2 GAS CONNECTION

Place burner assembly into the firebox shelf as shown. Ensure that burner sits fully down into the round hole, and rim of burner is in full contact with the shelf all the way round. Fix the burner to the firebox shelf in the four screw positions indicated, using the stainless steel screws and allen key provided.

Purge the gas supply thoroughly to remove air and dirt/debris **BEFORE** connection. Now connect the previously installed gas supply to the control tap and tighten all joints. Soundness test installation.

If using an across hearth connection, ensure the decorative fire-frame will clear the supply route.

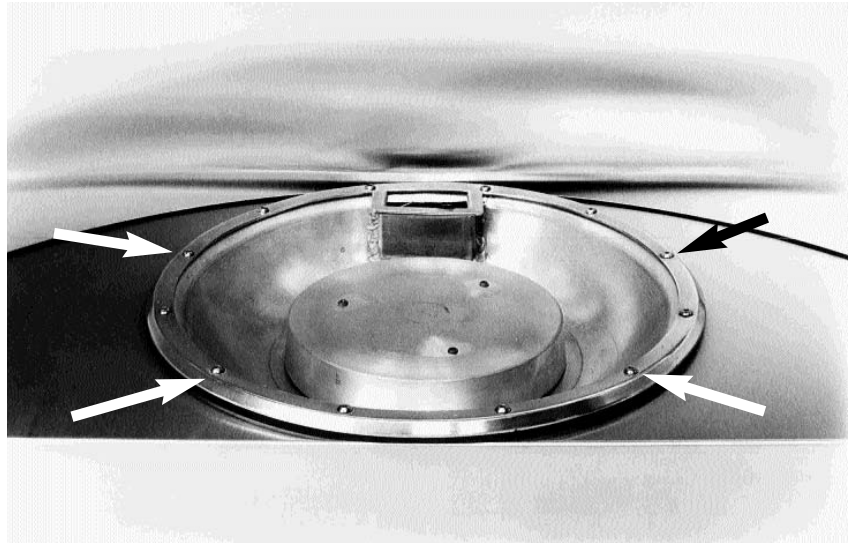

12.0 FUEL BED LAYOUT

Please refer to the relevant section of the user manual section of this booklet.

13.0 FITTING THE FRAME

The appliance is supplied with a stainless steel frame, which is supplied in 4 pieces. Assemble by following the enclosed instruction sheet. The frame is held onto the firebox by two mounting brackets at the top and magnets at the base. The brackets may be adjusted to provide a perfect fit. It is recommended that the brackets be bent to approximately 40 degrees from the vertical position. **Do not overbend the brackets.**

Lift the stainless steel frame into position on the front of the firebox. The plastic protective film may be removed from the firebox and frame at this stage.

14.0 TESTING AND COMMISSIONING

Turn on and test the gas supply up to the fire for any leaks, in accordance with current Approved Codes Of Practice (ACOPs).

When the appliance is first used, protective oils coating the firebox may burn off. It is advisable to ventilate the room during this period, at least one hour.

14.1 OPERATING THE FIRE

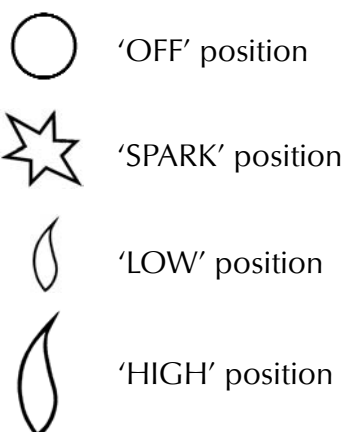

The control knob of the fire is marked as follows ;

The pilot is visible at the rear of the burner. Push in and turn the control knob to the SPARK position, and hold there for a few seconds.

Continue turning anti-clockwise through the spark click, ensuring the pilot has lit. If not, return the knob clockwise, and repeat.

When the pilot lights after the spark, keep the knob depressed for approximately ten seconds. Now release the knob and the pilot should stay alight. If not, retry ignition. If the pilot is extinguished during use, wait three minutes before repeating the ignition procedure.

To achieve the HIGH setting, push the control knob in slightly and continue turning anti-clockwise to the large flame position. The main burner should light after a few seconds.

14.1 OPERATING THE FIRE (continued)

To decrease the setting to LOW, turn the control knob clockwise to the low flame setting. The flame height may be adjusted as desired between high and low settings by turning the control knob to the required position between 'HIGH' and 'LOW'.

To turn to the PILOT position from the HIGH or LOW positions, press the control knob in, and return to the pilot position and release.

To turn the fire OFF, keep the knob pressed in, return to the off position and release.

14.2 SPARK FAILURE

The gap between the spark electrode and the pilot should be 3.5 - 4.5mm to produce a good spark. There should be no need to adjust this. If under any circumstances the electric spark fails, the pilot may be lit manually by proceeding with the ignition sequence as previously described, and after turning the control knob through the spark position, the knob should be held in and the pilot lit with a taper.

14.3 SETTING PRESSURE

Remove the screw from the pressure test point, situated on the main injector pipe to the left hand side of the decorative valve cover, and attach a U gauge. Light the fire on the HIGH setting.

The setting pressure should be in accordance with the figures stated on page 2 of these instructions. The fire is factory set to achieve these pressures, and any significant variation could indicate a supply problem. If the pressure is too high, the gas supply meter may be set incorrectly. This should be checked with the fire running and if necessary reset by the gas supplier.

If the pressure is too low, then check the meter governor pressure with the appliance running. If this is incorrect it will need to be reset by the gas supplier. If the setting pressure is too low, but the meter pressure is acceptable, then a problem in the supply pipework is to be suspected. This will be dirt and debris, kinked or inadequate size pipes, restriction in a fitting or solder flashing across a joint. (NOTE: you will not get an accurate reading of the inlet pressure with a pressure gauge on the end of the supply pipe - this is the static pressure in the system. You must use a T piece and measure the supply pressure with the fire on High - the dynamic pressure).

14.5 FLUE SPILLAGE MONITORING SYSTEM

This fire is fitted with a flue spillage safety device (ODS). If the fire shuts down during use for no apparent reason then several things may be suspected. If a door or window has been opened creating a draught, then pilot disturbance is the problem, and removal of the draught should resolve this. If a grommet seal has been left out of the firebox then this also will also cause intermittent shutdown (recall your installer to fit). The gas pressure reaching the fire must also be checked (again, recall your installer to check and rectify any problem). The thermocouple connection into the back of the gas control valve may also have worked loose during installation, simply get the installer to tighten.

If pilot disturbance is not the cause, then the ODS safety system may be in operation. Switch the appliance OFF, check the flue and carry out any remedial work required. Relight the fire and carry out a spillage test. DO NOT allow the appliance to be used if it continues to fail a spillage test.

The aeration hole of the pilot must be carefully cleaned out on each annual service to ensure continued function of the ODS.

The spillage monitoring system shall not be adjusted, modified, or put out of operation by the installer. Any spare parts fitted MUST be of a type supplied for the purpose by the appliance manufacturer.

If the fire is not spilling, then further guidance should be sought, using the Troubleshooting section as a guide.

14.6 TESTING FOR SPILLAGE

Close all doors and windows to the room containing the appliance. Let the fire run on HIGH for five minutes. Take a smoke match, light it, and using a smoke match tube, hold it at the top edge of the fire opening, 25mm down and 25mm in. Starting 50mm from either side, run the smoke match across the opening. All the smoke should be drawn away up the flue. Any smoke returning into the room indicates that spillage is occurring. If the initial spillage test fails, run the fire for a further 10 minutes and repeat the test. When the test has been completed satisfactorily, repeat with any extractor fans in the premises running on the highest setting, and any communicating doors open. Finally, repeat with all doors open.

NOTE: If spillage is still indicated after undertaking all of the above, there may be a fault in the flue, or insufficient ventilation is present.

If the problem cannot be rectified immediately, then expert advice should be sought. Inform the user, disconnect

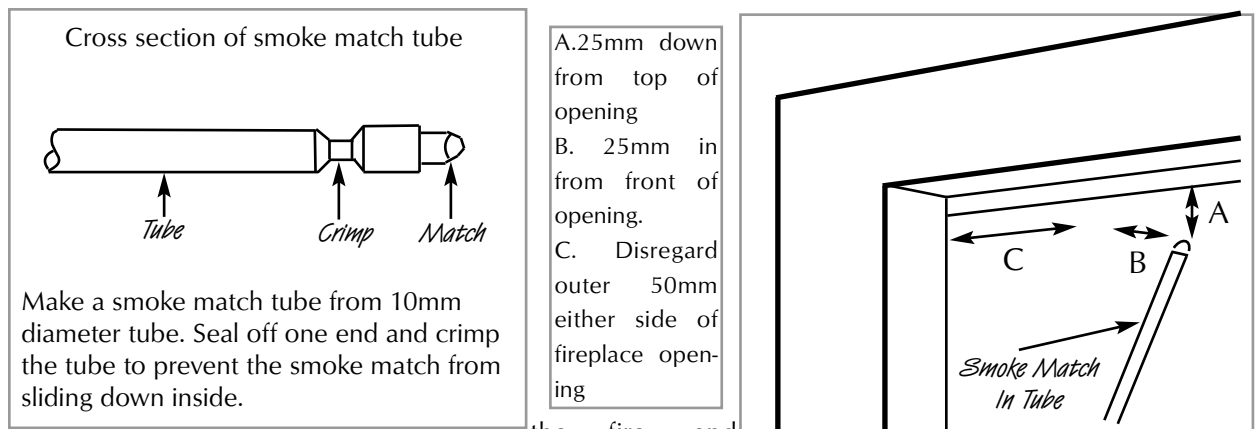

the fire, and attach an explanatory label.

14.7 BRIEFING THE CUSTOMER

All instructions must be handed to the user for safekeeping. **Show the customer how to light and control the fire.**

After commissioning the appliance, the customer should be instructed on the safe use of the appliance and the need for regular servicing. Frequency of service depends on usage, but **MUST** be carried out at least one annually.

Scatched and other superficial damage to the matt black paintwork underneath the shelf of the appliance can be covered with matching heatproof spray. Use only the manufacturers' recommended spray paint. Paint only when the fire is OFF and cold. Always mask off the surrounding area to prevent contamination with overspray. Ventilate the room during the use of the spray.

DO NOT attempt to spray paint the logs or ceramics, or wash them in water.

15.0 SERVICING

Ensure that the fire is fully cold before attempting service. A suggested procedure for servicing is detailed below.

1. Lay out the dust sheet and tools.
2. Carefully remove the stone effect front, and ceramic components.
3. Isolate the gas supply at the appliance isolation cock, and disconnect the gas supply pipe. Remove the four screws securing the burner unit to the firebox using the allen key provided.
4. Lift the burner unit from the firebox.
5. Remove the firebox as detailed in the relevant section.
6. Check the area behind the firebox for rubble accumulation and remove. If debris is excessive, initiate remedial work on the flue.

15.0 SERVICING (continued)

7. Check the flue with smoke pellet for correct operation.
8. Re-fit the firebox using new seals where necessary.
9. Strip off the burner pipes and clean thoroughly.
10. Clean out the injector and pilot assembly. DO NOT damage pilot injector.
11. Re-assemble and re-fit the burner tray.
12. Re-fit the the frame.
13. Re fit and replace the ceramics, using genuine spares where necessary.
14. Turn on the gas supply, and leak test.
15. Check any purpose provided ventilation is un-obstructed.
16. Light the fire and test for spillage.
17. Check setting pressure and safe operation of the appliance.

For specific servicing instructions, see the relevant sections of the user manual.

15.1 CLEANING THE LOGS/Pebbles

Carefully remove the ceramic components. Gently clean in the open air. Be careful not to create dust from the logs or pebbles. Where necessary replace damaged components with genuine spares. Seal scrap components in plastic bags and dispose of at proper refuse sites as directed.

Re-fit the logs /pebbles carefully by referring to the relevant section of these instructions.

15.2 REMOVING THE FIREBOX

Remove the firetray as previously described. Uncoil the fixing kit cables from the rear of the firebox, remove the screwed nipples and tensioning adjusters. The firebox can now be withdrawn from the opening and outwards onto the protected hearth. Inspect the fireplace opening for debris, and if excessive rectify the flue before proceeding further. Check the seal around the fireframe and replace if necessary. Refitting of the firebox is described in the relevant section.

15.3 DISMANTLING THE BURNER UNIT

Remove the burner unit as previously described. The pilot unit can be removed by undoing the tubing nut, the thermocouple nut on the rear of the valve, lint arrestor, two securing screws, and lifting away. Remove the tubing nut from the valve end of the pilot pipe, and blow through to dislodge any debris that may be present. Clean the exterior of the pilot assembly with a soft brush and blow through the flame ports on the pilot head. Check the aeration holes are free from lint or dirt. The pilot assembly is a non-serviceable item, and should not be taken apart. The aeration hole must be absolutely clear internally for proper operation. A thoroughly cleaned (inside and out) oxypilot will cure a wide range of ignition faults.

Undo the two tubing nuts on the ends of the gas pipe to the injector elbow and remove. The injector pipe can now be checked for debris. Remove the nut retaining the injector elbow. Blow through the elbow to remove any debris.

The valve is not field serviceable, apart from the pilot filter. Remove the control knob by removing the spring clip connecting the valve spindle to the control knob spindle. Remove the decorative valve cover, then remove the largest of the three screws on the face of the valve. Slide the filter out and clean away any debris that may have accumulated. The filter element should also be blown clean. This component should not require replacement, however if signs of deterioration are evident then a genuine spare must be used. If a large amount of debris is present in the filter then the pipework and control should be thoroughly cleaned before re-assembly.

16.0 TROUBLESHOOTING GUIDE

<i>Fire sparks but pilot does not light</i>	No gas to fire, check isolators are open. Pipework blockage, clean out. Air not fully purged, repurge supply or wait longer. Spark earthing to metal work, reset gap correctly. Blocked pilot, clean out internally.
<i>Pilot lights but then goes out</i>	Severe restriction in gas supply, clear obstruction. Faulty thermocouple, replace pilot unit. Hold control knob in for longer.
<i>Fire does not spark at pilot</i>	HT lead detached, refit. Spark gap too large or small, reset correctly. Faulty piezo unit, replace. Debris shorting out electrode, clean.
<i>Fire runs for a time and then cuts off</i>	Excessive room draught or flue pull, rectify. Loose or faulty thermocouple, rectify. ODS system in operation. Firebox grommet seal not fitted, rectify. Lint in pilot aeration hole, clean thoroughly internally
<i>Pilot flame shrinks when fire is on high</i>	Poor gas flow to fire, check pressure with fire on high. If pressure is low, remove any restriction in pipework or valve. Check all isolators are adequately sized and fully open. Check meter pressure is adequate. Air leak under base of firebox, rectify. Lint in pilot aeration hole, clean thoroughly internally.
<i>Fire smells when first lit or in use</i>	Newness smell from brand new appliance. Spillage occurring. Carry out spillage test and rectify any problems. Low temperature sealants or combustible materials used in incorrect positions. Air leak under base of firebox, rectify.

USER INSTRUCTIONS

<i>Section</i>	<i>Contents</i>	<i>Page No.</i>
1.0	Important Notes	1
2.0	Clearances to Combustibles	2
3.0	Ventilation	2
4.0	Operating the fire	2
5.0	Fuel bed layout	3
6.0	Flue Spillage Monitoring System	6
7.0	Cleaning	6
8.0	List of Spares	7

1.0 IMPORTANT NOTES

The installation of this fire **MUST** only be carried out by a competent person (such as a CORGI registered fitter) in accordance with the Gas Safety (Installation and Use) Regulations 1998, the relevant British Standards, Codes of Practice, the Building Regulations and the manufacturers' instructions.

Failure to comply with the above recommendations could lead to prosecution and invalidate the appliance warranty.

Please ensure you are handed all of the manufacturers documents on completion of the installation. This will include these instructions.

Always keep a note of the installer's name and address, the original purchase receipt and the date of installation for future reference.

The fire and flue should be serviced regularly to ensure continued safe operation. See the servicing section for further details. Frequency of service will depend on use, but **MUST** be carried out at least once annually.

Parts of this appliance become naturally hot during use. It is recommended that a suitable fire guard conforming to BS 6778 is used, especially where young children, the elderly, or infirm are concerned.

Combustible items, such as flooring and furniture, and soft wall coverings (such as blown vinyl or embossed paper) may discolour if fitted too close to the fire. See relevant section for further details on clearances to combustibles. No combustible material or flooring should protrude onto the hearth.

DO NOT burn any foreign material on this fire, the logs must be of the correct type and laid out in accordance with the relevant section of these instructions. Failure to do so could create a hazard or lead to sooting.

Before the appliance is installed, the chimney should be swept. All flues should be checked by the installer to ensure there are no defects or obstructions that may prevent the flow of combustion products.

This appliance is fitted with a flue blockage safety device which will shut down the fire if abnormal flue conditions occur. It is **NOT** a substitute for an independently mounted Carbon Monoxide detector.

The fire is only suitable for use with the gas type for which it is supplied.

2.0 CLEARANCES TO COMBUSTIBLES

A combustible shelf may be fixed to the wall above the fire, providing that it complies with the dimensions given below.

<i>Maximum depth of shelf</i>	<i>Minimum distance from surface of hearth to underside of shelf</i>
100mm (4in)	860 mm (34 in)
150mm (6in)	970 mm (38 in)
203mm (8in)	1020 mm (40 in)

A non-combustible shelf may be fitted to within 30mm of the top edge of the decorative frame.

Combustible materials, such as wood, may be fitted to within 100mm (4in) of either side of the frame of the appliance, providing the forward projection does not exceed 100mm (4in).

Any combustible side walls must be at least 500mm to the side of the radiant heat source.

As with all heating appliances, any decorations, soft furnishings, and wall coverings (i.e. flock, blown vinyl and embossed paper) positioned too close to the appliance may discolour or scorch.

3.0 VENTILATION

No purpose provided ventilation is normally required for this appliance. The requirements of other appliances operating in the same space or room, and the results of a spillage test must be taken into consideration when assessing ventilation requirements, this will have been carried out by your CORGI registered installer.

For Republic of Ireland, ventilation may be required, see IS 813, ICP3, IS 327, and any other rules in force.

4.0 OPERATING THE FIRE

The control knob of the fire is marked as follows ;



'OFF' position

The pilot is visible at the rear of the burner. Push in and turn the control knob to the SPARK position, and hold there for a few seconds.



'SPARK' position

Continue turning anti-clockwise through the spark click, ensuring the pilot has lit. If not, return the knob clockwise, and repeat.



'LOW' position

When the pilot lights after the spark, keep the knob depressed for approximately ten seconds. Now release the knob and the pilot should stay alight. If not, retry ignition. If the pilot is extinguished during use, wait three minutes before repeating the ignition procedure.



'HIGH' position

To achieve the HIGH setting, push the control knob in slightly and continue turning anti-clockwise to the large flame position. The main burner should light after a few seconds.

To decrease the setting to LOW, turn the control knob clockwise to the low flame setting. The flame height may be adjusted as desired between high and low settings by turning the control knob to the required position between 'HIGH' and 'LOW'.

To turn to the PILOT position from the HIGH or LOW positions, press the control knob in, and return to the pilot position and release.

To turn the fire OFF, keep the knob pressed in, return to the off position and release.

5.0 FUEL BED LAYOUT

1. Fill burner with vermiculite as shown. Ensure that the vermiculite is level and flat and is filled fully up to the rim of the burner. Do not press, pat or otherwise compact the vermiculite beyond it's own weight.

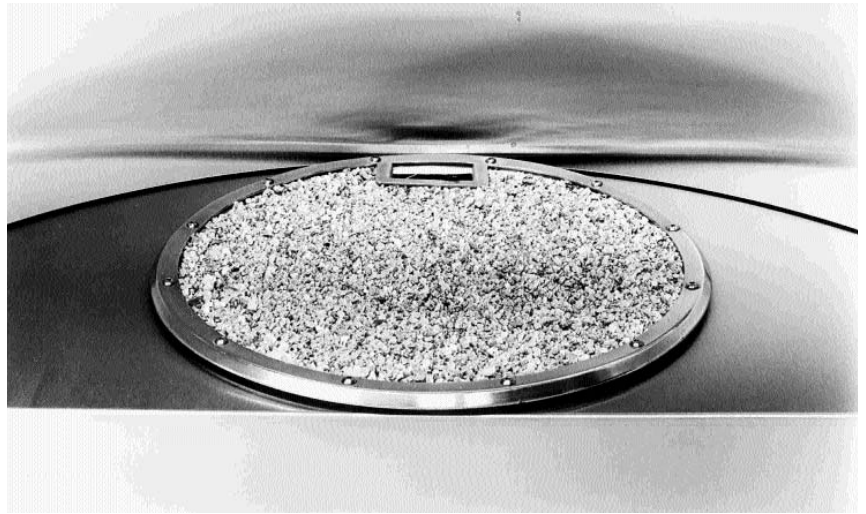

2. Place the ceramic log support centrally on top of the vermiculite bed as shown. The four flat faces of the log support should be facing downwards. Do not press the log support downwards, as this will compact the vermiculite.

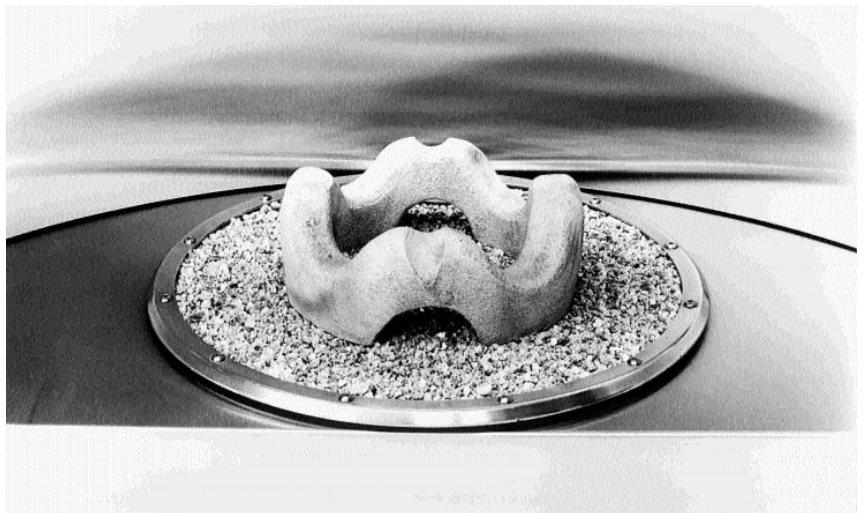

3. The ceramic log set comprises of Eight large logs, and six smaller ones. Initially, put the six smallest logs to one side. Next, take two of the larger logs and position as shown, towards the back of the burner with one end of each log resting on the log support. The other ends of the logs may rest on or near to the metal rim of the burner. The logs should be pointing towards the centre of the log support.
IMPORTANT : Do not obstruct view of the pilot unit.

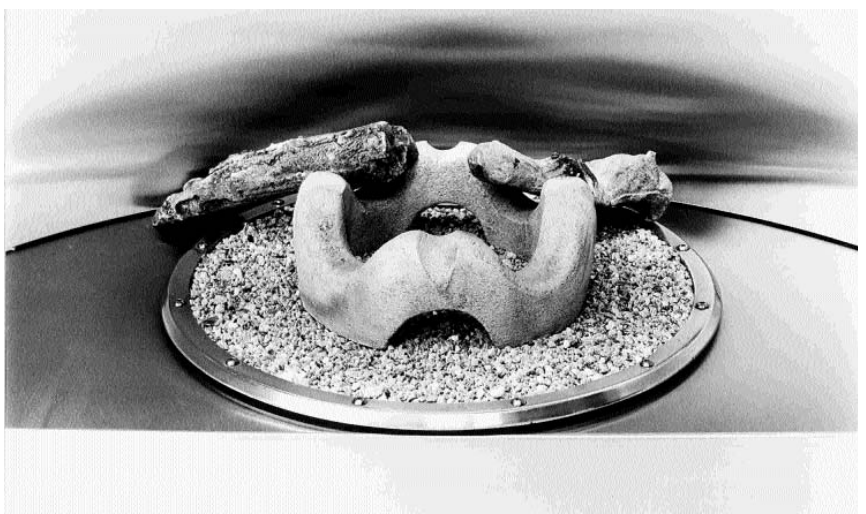

5.0 FUEL BED LAYOUT (continued)

4. Take two more of the large logs and once again position one end of each on the raised parts of the log support, and the other ends on or near to the metal burner rim as shown.

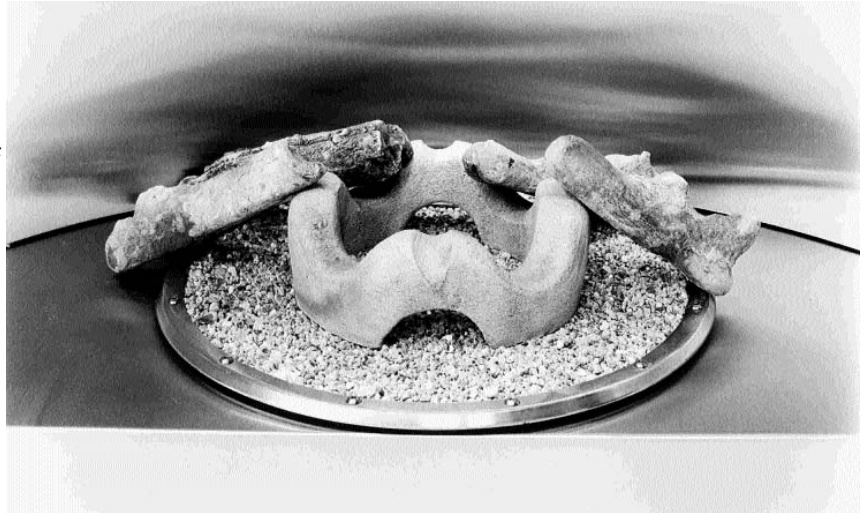

5. Once again, take two more of the large logs and position one end of each on the raised parts of the log support, and the other ends on or near to the metal burner rim as shown.



6. Now take three of the smaller logs and position on the vermiculite bed in between some of the larger logs you have just laid. The position of the smaller logs may be as required in order to achieve a realistic, random looking effect (see highlighted).

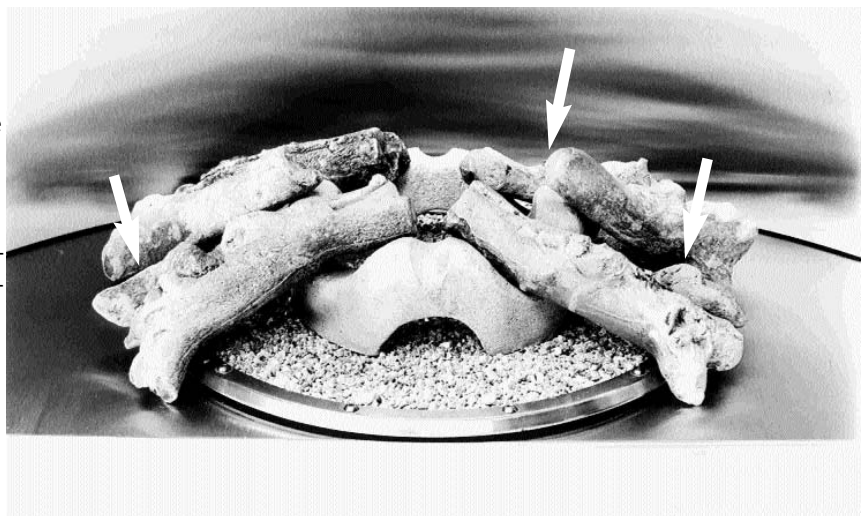

5.0 FUEL BED LAYOUT (continued)

7. Take three further small logs and position at the front of the log support as shown, resting partly on the log support, and partly on the metal edge of the burner.



8. Finally, take the two remaining large logs, and lay directly on top of the log support as shown. Once again the exact position of these logs may be as desired, in order to achieve a natural, realistic looking effect. Some slight adjustment may be required when the fire is running to achieve the optimum flame effect.

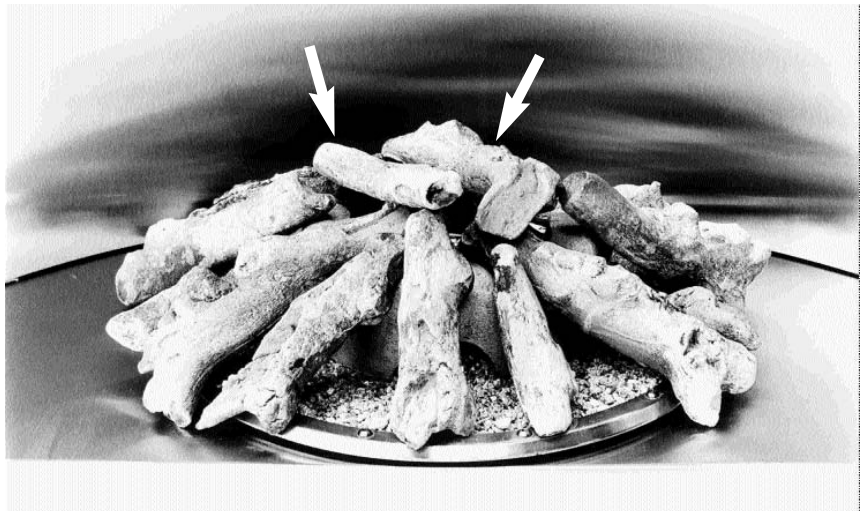

5.1 FUEL BED LAYOUT (Glass/pebble models)

Important : Wear protective gloves when handling the glass crystals.

1. Fill the burner with glass crystals as shown. The crystals should be spread evenly and level up to the same level as the edge of the burner.

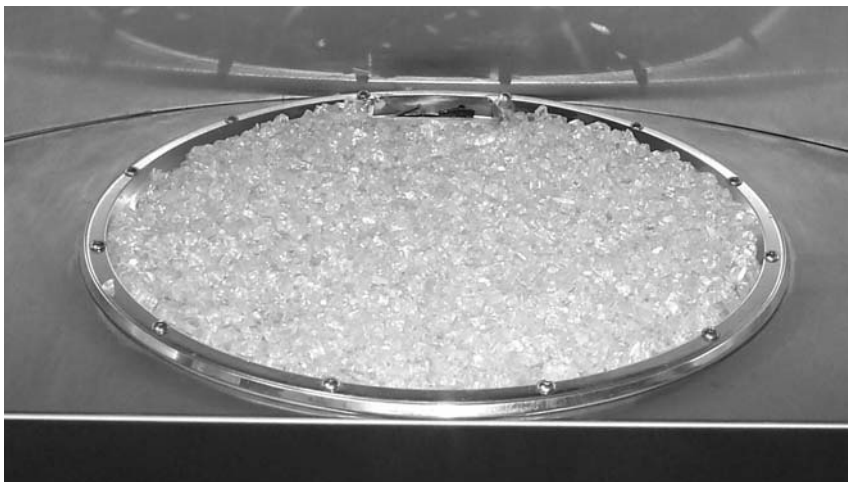

5.1 FUEL BED LAYOUT (Glass/pebble models)

2. Open the bag of 10 ceramic pebbles. All of these pebbles are the same size, but may vary slightly in shape in order to create a natural effect. Take seven pebbles and place them as shown, in the centre of the burner.



3. Take four more pebbles and place them as shown, on top of the first six pebbles



The fire is designed to operate correctly with the pebbles supplied when assembled according to the instructions. Never add to the ten pebbles, or change them for a different type. Never throw rubbish or other matter onto the fuel bed.

Due to the light colour of the pebbles, some discolouration/sooting is to be expected during normal use.

6.0 FLUE SPILLAGE MONITORING SYSTEM

This fire is fitted with a flue spillage safety device (ODS). If the fire shuts down during use for no apparent reason then several reasons may be suspected. If a door or window has been opened creating a draught, then pilot disturbance could be the problem, and removal of the draught should resolve this. The fire can then be re-lit in accordance with the previous section. A sealing grommet may have been omitted when the fire was installed, and the original installer should be called to check this, the gas pressure and pipework.

If pilot disturbance is not the cause, then the ODS safety system may be in operation. Switch the appliance OFF, call in your installer to check the flue and ventilation and carry out any remedial work required. DO NOT allow the appliance to be used until the flue system is passed as safe.

7.0 CLEANING

Before carrying out any of the following operations, ensure that the fire is OFF and completely cold.

Debris that may form on the firebed should be periodically removed by a competent person. Large deposits could indicate deterioration of the flue. This should be repaired by a competent person, and the fire serviced before further use.

FIREFRAME - The appliance is supplied with a stainless steel frame. The frame is held onto the firebox by two mounting brackets and magnets. The stainless steel frame may be removed for cleaning if required, see stainless steel areas below.

7.0 CLEANING (continued)

PAINTED AREAS - These can be cleaned using a dry cloth.

STAINLESS STEEL AREAS - These areas may be cleaned using a soft damp cloth or stainless steel cleaner.

IMPORTANT - Always clean in the direction of the grain, and never across it as this will scratch the surface. It is recommended that a small inconspicuous area is attempted before cleaning the entire stainless steel area - to ensure the cleaning material is suitable.

LOGS AND CERAMICS - Carefully remove the ceramic components. Gently clean in the open air. Be careful not to create dust from the logs or pebbles. Where necessary replace damaged components with genuine spares. Seal scrap components in plastic bags and dispose of at proper refuse sites as directed.

Re-fit the logs carefully by referring to the relevant section of these instructions.

GLASS CRYSTALS - If necessary, the glass crystals may be removed from the firebowl and cleaned in lukewarm mild soapy water. Rinse thoroughly in clean water and ensure the glass is completely dry before refilling.

Important - Wear protective gloves when handling the glass crystals.

8.0 LIST OF SPARES

<i>PART NO.</i>	<i>ITEM</i>
CE/F550060	Pack of 8 large ceramic logs (Log Version Only)
CE/F550061	Pack of 6 small ceramic logs (Log Version Only)
CE/F780019	Ceramic log support (Log Version Only)
CE/F780037	Bag of vermiculite (Log Version Only)
CE/F550071	Pack of 10 individual Ceramic Pebbles (Glass/pebble models only)
CE/F920006	Pack of heat resistant Glass Crystals (Glass/pebble models only)
FR/F550067	4 Sided Stainless Steel Frame
FT/F730015	Control valve
FT/F730006	ODS pilot unit
FT/F730016	Injector
FT/F870009	Control knob