



# Emberglow

## COAL EFFECT BALANCED FLUE GAS FIRE

**Installation and Maintenance Instructions**

**Hand these instructions to the user**

**Model No's FEBC00MN is for use on Natural Gas (G20) at a supply pressure of 20 mbar in G.B. / I.E.**

# CONTENTS

		PAGE
<b>Section 1</b>	<b>Information and Requirements</b>	
1.0	Appliance Information	3
1.1	Conditions of Installation	4
1.2	Fireplace surround & suitability	4
1.3	Flue Terminal Position	5
1.4	Shelf position	6
1.5	Hearths	6
<b>Section 2</b>	<b>Installation of Fire</b>	
2.1	Unpacking the fire	6
2.2	Preparation of the wall	7
2.3	Preparation of the flue hole	8
2.4	Preparation of the flue pipes	9
2.5	Installation of the gas supply	10-11
2.6	Securing of the combustion chamber to the wall	11-12
2.7	Fitting the terminal guard	12
2.8	Removal & refitting of the glass frame	13
<b>Section 3</b>	<b>Assembling Fuel Bed and Commissioning</b>	
3.1	Fitting the fuel bed	14
3.2	Lighting the appliance	15-16
3.3	Fitting the fender	17
3.4	Fitting the canopy	17
<b>Section 4</b>	<b>Maintenance</b>	
4.1	Removal of the Burner Assembly	18
4.2	Removal of the Control Valve	18-19
4.3	Removal of the Battery Pack	19
4.4	Removal of the Pilot Assembly	19
4.5	Removal of the Touch Control Switch	19-20

The model no. of this appliance is on the rating plate, which is affixed to the battery pack retaining bracket on the front right hand side of the fire. The product is manufactured by:-

CFM Europe Ltd, Trentham Lakes, Stoke-on-Trent, Staffordshire, ST4 4TJ

## SECTION 1 INFORMATION AND REQUIREMENTS

### 1.0 APPLIANCE INFORMATION

Main injector : (1 off)	Bray Injector Elbow – size 360
Pilot Type :	S.I.T.140 Series    NG – size 27
Max. Gross Heat Input :	5.25 kW
Min. Gross Heat Input :	2.05 kW
Gas Rate :	0.470 m <sup>3</sup> /hr (High) 0.190 m <sup>3</sup> /hr (Low)
Cold Pressure :	20.0+/-1.0 mbar (8.0 +/- 0.4 in w.g.)
Ignition :	Integral to gas valve
Electrode Spark Gap :	4.0mm
Weight (Product & Fender) :	33 kg
Weight (Canopy) :	23 kg

**Fig 1 -  
Product  
Dimensions**

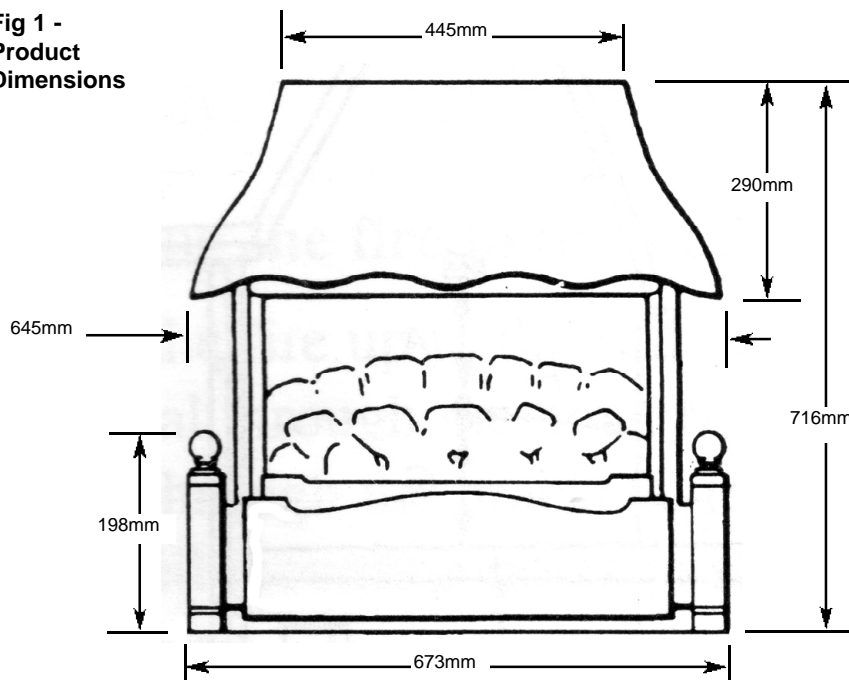

## INSTALLATION REQUIREMENTS

### 1.1 CONDITIONS OF INSTALLATION

#### In Great Britain :-

It is the law that all gas appliances are installed only by a CORGI Registered Installer, in accordance with these installation instructions and the Gas Safety (Installation and Use) Regulations 1998 as amended. Failure to install appliances correctly could lead to prosecution. It is in your own interest and that of safety to comply with the law.

The installation must also be in accordance with all relevant parts of the Local and National Building Regulations where appropriate, the Building Regulations (Scotland Consolidation) issued by the Scottish Development Department, and all applicable requirements of the following British Standard Code of Practice.

1. B.S. 5871 Part 3 Installation of Decorative Fuel Effect Gas Fires
2. B.S. 6891 Installation of Gas Pipework
3. B.S. 5440 Parts 1 & 2 Installation of Flues and Ventilation
4. I.S. 813 : 1996 Domestic Gas Installation (Republic of Ireland)

If installing this product into a timber framed building, please consult document IGE / UP 7, issued by the Institute of Gas Engineers.

#### In Republic of Ireland :-

**No purpose made additional ventilation is normally required for this appliance, when installed in G.B. When Installing in I.E. please consult document I.S. 813 : 1996 Domestic Gas Installation, which is issued by the National Standards Authority of Ireland. If installing in Northern Ireland, please consult local building regulations. Any purpose made ventilation must be checked periodically to ensure that it is free from obstruction.**

### 1.2 FIREPLACE / SURROUND SUITABILITY

The fire must only be installed on a hearth it **must not be installed directly onto carpet or other combustible floor materials.**

The fire is suitable for fitting to non-combustible fire place surrounds and proprietary fire place surrounds with a temperature rating of at least 150°C.

**If a heating appliance is fitted directly against a wall without the use of a fire surround or fire place all combustible material must be removed from behind the trim. Soft wall coverings such as blown vinyl, wall paper etc. could be affected by the rising hot air and scorching and/or discoloration may result. Due consideration should be made to this when installing or decorating.**

### 1.3 FLUE TERMINAL POSITION

The minimum acceptable dimensions from the flue terminal to obstructions and ventilation openings are shown below and listed in the table. It is important that the position of the flue allows the free passage of air across it at all times. The minimum acceptable space from the flue terminal to obstructions and ventilation openings are specified below (Fig. 2)

Fig. 2

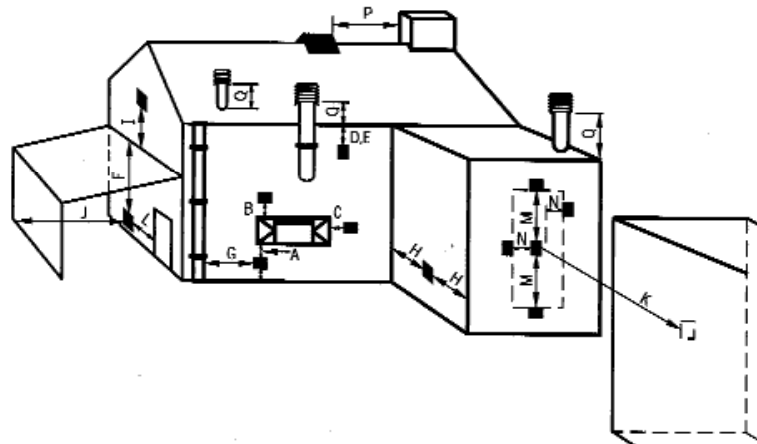

DIMENSION	TERMINAL POSITION	MINIMUM DIMENSION
A	Directly below an opening, air brick, opening window	300mm (12in)
B	Above an opening, air brick, opening window	300mm (12in)
C	Horizontally to an opening, air brick, opening window etc.	
D	Below gutters, soil pipes or drain pipes	300mm (12in)
E	Below eaves	300mm (12in)
F	Below balconies or car port roof	600mm (12in)
G	From a vertical drain pipe or soil pipe	300mm (12in)
H	From an internal or external corner	600mm (24in)
I	Above ground roof or balcony level	300mm (12in)
J	From a surface facing the terminal	600mm (24in)
K	From a terminal facing the terminal	600mm (24in)
L	From an opening in the car port	1200mm (48in)
M	Vertically from a terminal on the same wall	1500mm (59in)
N	Horizontally from a terminal on the same Wall	300mm (12in)
O	NOT APPLICABLE	N/A
P	NOT APPLICABLE	N/A
Q	NOT APPLICABLE	N/A

#### 1.4 SHELF POSITION

The fire may be fitted below a combustible shelf providing there is a minimum distance of 200mm above the top of the fire and the shelf does not project more than 150mm. If the shelf overhangs more than 150mm the distance between the fire and the shelf must be increased by 15mm for every 25mm of additional overhang over 150mm.

#### 1.5 HEARTHES

This appliance must only be installed on to a level concrete or non-combustible hearth. The feet must not be removed when installing directly onto a hearth. The hearth material must be a minimum thickness of 13 mm with the outer perimeter of the hearth panel at least 50 mm above the floor level, to discourage the placing of carpet or other floor coverings over it. The hearth **must** be fitted symmetrically about the fire opening and have a minimum width of 760 mm and a minimum projection of 350 mm forwards from the fire opening.

### SECTION 2 INSTALLATION OF FIRE

#### 2.1 UNPACKING THE FIRE

Carefully lift the fire out of the carton. Remove the loose item packaging carefully from the the pack. Check the contents as listed :-

**DO NOT UNDER ANY CIRCUMSTANCES USE THIS APPLIANCE IF THE GLASS PANEL IS BROKEN OR NOT SECURELY FIXED TO THE FIREBOX.**

#### Packing Check List

Pack 1 of 1

1off	Combustion chamber / burner assembly
1off	2 piece fuel-bed set (packed in seperate carton)
1off	Flue pipe and flue terminal unit
1off	Installation & Maintenance Instruction Book
1off	User Instruction Book
1off	Loose items pack
1off	Cooler plate
2off	Brass finials - to be screwed into casting upon commisioning
2off	Decorative side trims & 4 off side trim fixing screws

Pack 2 of 2

1off	Cast iron canopy assembly
------	---------------------------

## 2.2 PREPARATION OF THE WALL

The appliance and flue pipes must be installed at right angles to the mounting wall. The appliance itself should be installed vertically against a flat wall. Where an uneven wall surface is found, appropriate action should be taken to ensure that the appliance is not stressed or does not distort when installed.

Ensure that the floor surface onto which the appliance is mounted onto is flat, and the hearth size conforms to the requirements of section 1.5 on page 6.

The minimum height from the floor to the centre of the flue is shown on fig. 3 below.

**Fig. 3**

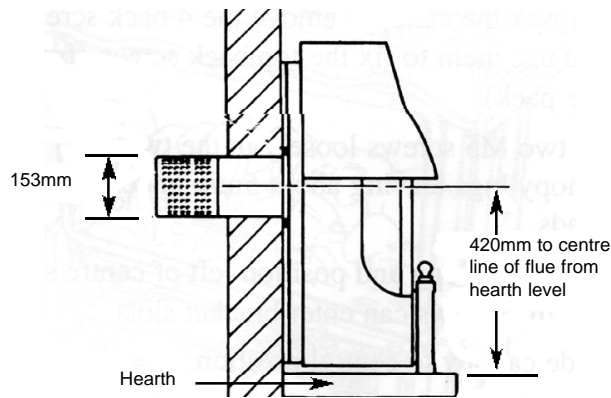

A min / max sized opening with a flat rear face between the fire opening and flue outlet terminal is shown below. (fig 4).

**Fig. 4**

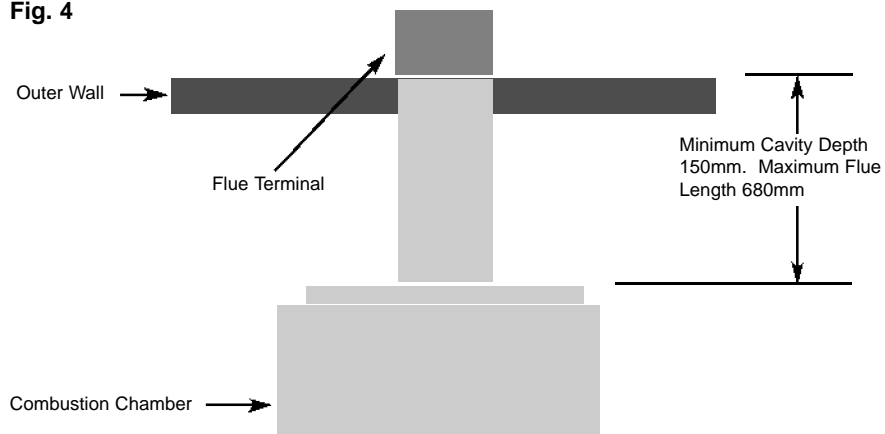

### 2.3 PREPARATION OF THE FLUE HOLE

- a) Mark the position of the centre of the flue on the inner wall.
- b) Cut hole for outer flue pipe. There are two possible methods to achieve this, either core drill or via hammer and chisel.
- c) To core drill, proceed as follows :-

Drill a pilot hole through the wall, in position as specified in figure 4.

Using a 6" core drill, drill the flue hole.

To Hammer and chisel, proceed as follows :-

Mark the position of the centre of the flue pipe as specified in figure 4.

Mark the position of the hole around this point.

Chisel out the area as marked on the wall.

We then recommend that a cardboard cylinder is placed around the flue pipe and inserted in the chiselled out hole whilst making good.

**NOTE :-** If the appliance is to be installed into a building under construction, it is recommended that a non-corrosive metal tube of 6" diameter be inserted into the position of the hole as specified on page 7.

Prior to installing the combustion chamber and flue pipe assembly, ensure the decorative side trims are secured with the screws as shown below in Fig. 5 a

**Fig. 5a**

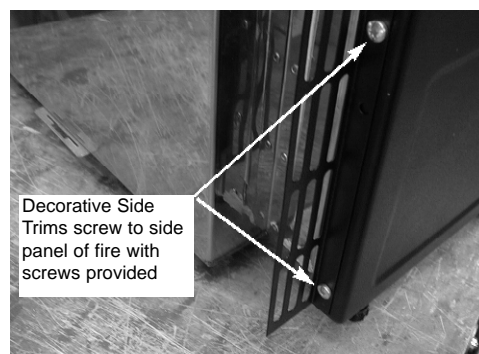



## 2.4 PREPARATION OF THE FLUE PIPES

- a) Measure the wall thickness and add on 110mm, to give the correct length of the flue.
- b) Mark this dimension onto the flue pipe, measuring from the end at which the terminal is located.
- c) Cut off surplus flue length that is not required, and remove any burrs from the edges with a burr knife or file.
- d) Push the flue pipe / terminal assembly firmly into the rear of the combustion chamber as shown below in Fig. 5
- e) Drill 3 off holes, through outer flue pipe and into the mounting spigot, and screw flue pipe and terminal assembly into place, as shown below in Fig. 5b

**Fig. 5b**

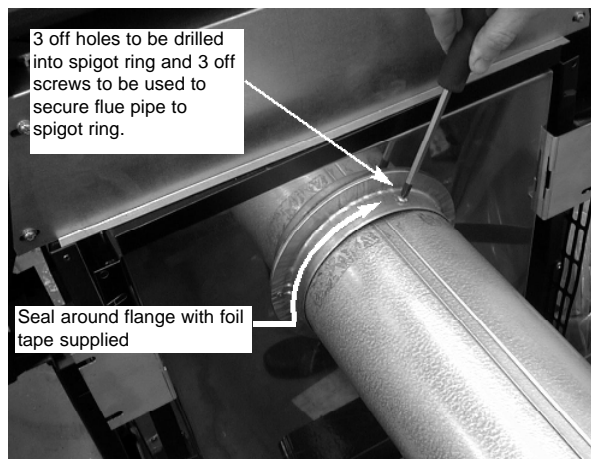

**IMPORTANT : DO NOT CUT FLANGED ENDS OF FLUE PIPE & ENSURE THE PIPES ARE CUT SQUARELY.**

- f) Using mortar or sealing compound, seal the outer flue pipe to the outside surface of the wall, (See Fig. 6 for position of mortar).

**Fig. 6**

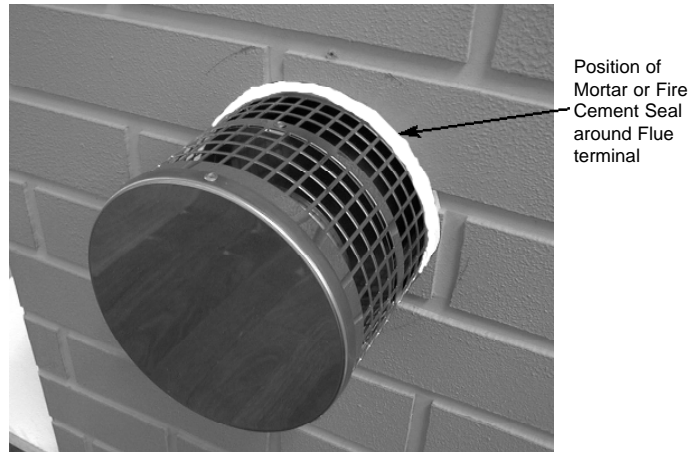

## 2.5 INSTALLATION OF THE GAS SUPPLY

- a) An 8mm restrictor elbow is supplied fitted to the product for the connection of the gas supply. This elbow is situated on the right hand side of the product when viewed from the front. It is therefore suitable for rear or right hand side gas supply. See Fig. 7 below.

**Fig. 7**

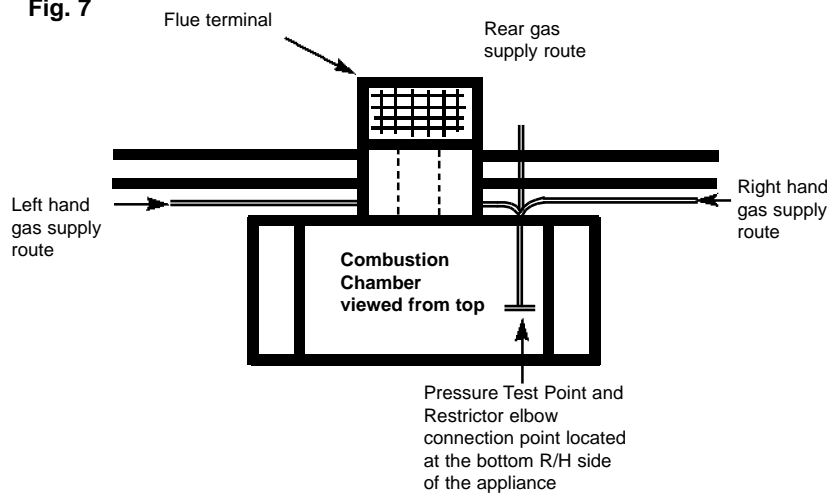

**Note :** Before breaking into the gas supply a pressure drop test should be carried out to establish that the existing pipework is sound.

- b) Before making the final gas connection, thoroughly purge the gas supply pipework to remove all foreign matter, otherwise serious damage may be caused to the gas control valve on the fire. Failure to purge the gas supply will invalidate the guarantee.
- c) The gas connection should be made to the appliance inlet elbow to using 8mm rigid tubing.
- d) Remove the pressure test point screw from the inlet elbow and fit a manometer.
- e) Turn on the main gas supply and carry out a gas tightness test.
- f) To light the appliance, refer to section 3.2 on pages 15 to 17.

**NOTE :** Please ensure that the battery that has been disconnected at the factory prior to packing is re-connected. The battery is located at the bottom L/H/S of the combustion chamber, attach the flying lead to it

- g) Check that the gas pressure is **20.0 mbar (+/- 1.0mbar) 8.0 in w.g.(+/- 0.4 in w.g.)**
- h) Turn off the fire, remove the manometer and refit the pressure test point screw. Check the pressure test point screw for gas tightness with the appliance turned on using a suitable leak detection fluid or detector.

## 2.6 SECURING OF THE COMBUSTION CHAMBER TO THE WALL

- a) The combustion chamber should be secured to the wall using the 4 off screws and rawplugs provided. Drill 4 off 6.0mm diameter holes into the wall behind the product as shown below in Fig. 8

**Fig. 8**

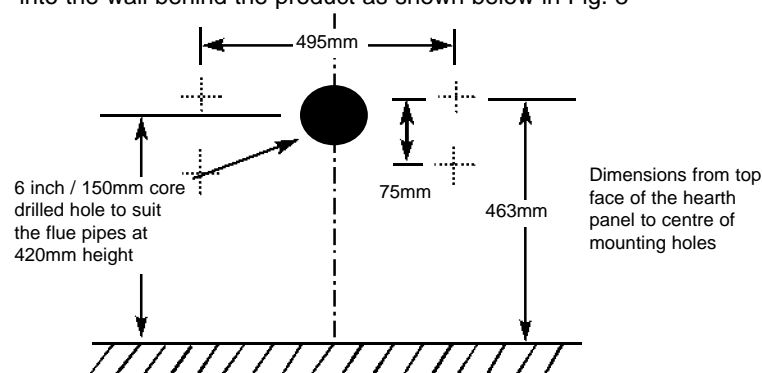

- b) Fit the rawlplugs into the 6mm holes.
- c) Clip the cooler plate into the bottom central fixing and into the left hand and right hand mounting brackets (the same brackets used in section d) below)
- d) The mounting brackets are attached to the rear of the combustion chamber, position the product against the mounting wall and using a long philips screwdriver, secure the 2 off screws into the wall behind the product.

**NOTE :** In England & Wales, the building regulations require that a terminal guard should be fitted if the terminal could come into contact with people near the building or be subject to damage. CFM Europe also recommend the fitting of a flue terminal guard where regulations do not demand that it be fitted. A suitable flue terminal guard can be obtained from CFM Europe Ltd. quoting part no. 70-46560

#### **2.7 FITTING THE OPTIONAL EXTRA TERMINAL GUARD**

With the flue terminal in position, place the terminal guard over the top of the flue terminal and mark the position of the holes on the outer wall. Remove the terminal guard and drill the 4 off 6 mm holes. Insert the rawl plugs into the drilled holes, replace the terminal guard over the top of the flue terminal and attach to the wall using the No.12 x 40mm screws provided with the terminal guard. See Fig. 9 below.

**Fig. 9**



## 2.8 REMOVING / RE-FITTING THE GLASS FRAME ASSEMBLY

- a) The glass frame is held in position by hooking the top flange over the combustion chamber opening at the top as shown in Fig. 10 below.

Fig. 10

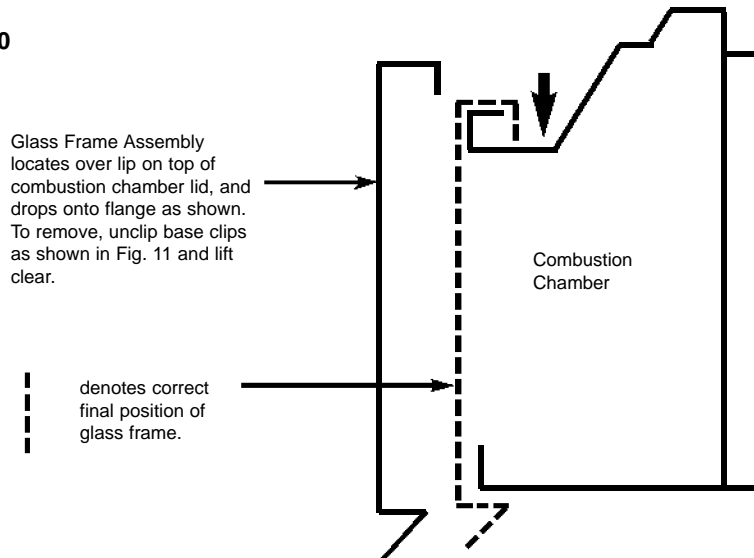

- b) The assembly is then secured to the bottom of the combustion chamber by the two hinge clamp brackets as shown below in Fig. 11. These are clamped together to form the seal between the glass frame assembly and the combustion chamber.

**NOTE :** Always ensure that a consistent seal between the combustion chamber and the glass frame is achieved.

Fig. 11

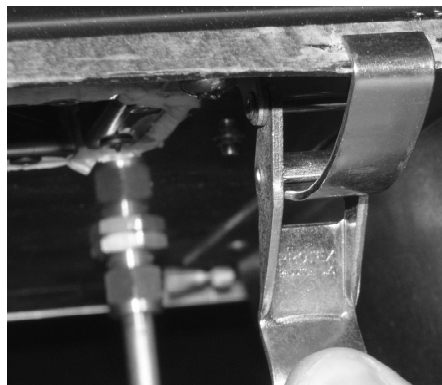

### SECTION 3 ASSEMBLING FUEL BED AND COMMISSIONING

#### 3.1 FITTING THE FUELBED

- a) Place the fuel-bed rear section centrally in the combustion chamber as shown below in Fig. 12

Fig. 12

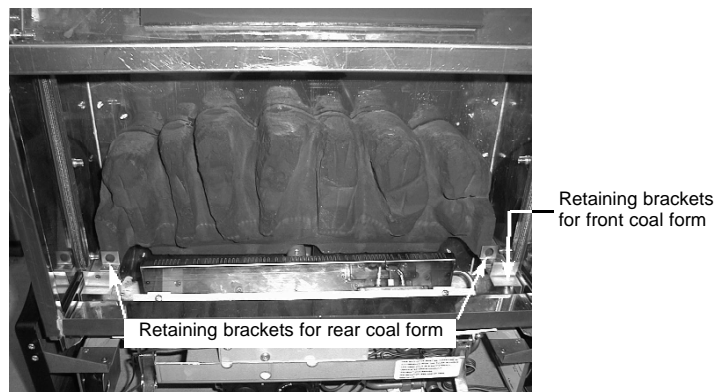

- b) Fit the front ceramic coal form in front of the burner, as shown below in Fig 13. Ensure that the front ceramic coal form is correctly located behind the retaining brackets at the L/H & R/H ends.

Fig. 13



Refit the glass frame as detailed in section 2.8, then light the appliance as detailed in section 3.2 below.

### 3.2 LIGHTING THE APPLIANCE

**IMPORTANT** : IF THE BURNER IS EXTINGUISHED FOR ANY REASON YOU MUST ENSURE THAT YOU WAIT A FULL FIVE MINUTES BEFORE ATTEMPTING TO RE-LIGHT THE FIRE.

Fig. 14

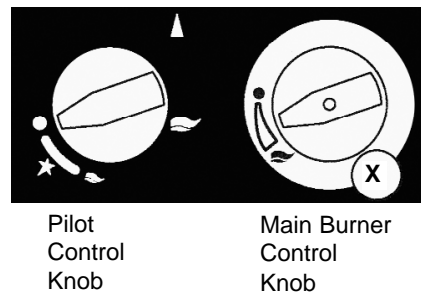

- a) Locate the control valve on the appliance, it is situated below the combustion chamber in the centre. There are two control knobs on the appliance, the left control knob controls the pilot ignition, the right hand control knob controls the main burner. This appliance is designed to run with the pilot permanently running, and the touch control can then be used to light the main burner, and control the gas rate between high and low. See Fig. 14 above for layout of controls.
- b) Depress the left control knob and rotate it anti-clockwise to the position marked pilot. (a click will be heard). Hold in the control knob for a few seconds whilst the air is purged from the supply pipe. Bring the knob back to its start position and turn it several times to the pilot position. The pilot should light. Hold in the control knob for at least 10 seconds to allow the thermocouple to heat up. Release the control knob. If the pilot fails to light, repeat the procedure as detailed above.
- c) Turn the left hand control anticlockwise to the large flame position and this allows the gas flow to enter the main burner section of the control valve. The main burner can then be controlled either manually on the valve or by the touch control switch, located at the bottom of the right hand side panel.
- d) **To adjust the heat input manually :-**  
  
With the pilot lit as detailed in section c) turn the right hand control knob anticlockwise to the X position (see Fig. 14 above). This allows gas to enter the main burner and be ignited by the pilot flame. Once the main burner has been lit, the right hand control knob can be adjusted to any position between the large flame (5.45kW heat input) position and the small flame (2.05kW heat input) position.

e) **To adjust the heat input via the touch control :-**

Press the “up” button to light the main burner and adjust the heat input to the maximum setting. (5.45kW heat input). Press the “down” button to reduce the heat input to the minimum setting (2.05kW heat input). **If the low button is pressed and held continuously, the fire will go past the minimum setting and extinguish the flames completely.** See Fig. 15 below.

**Fig. 15**

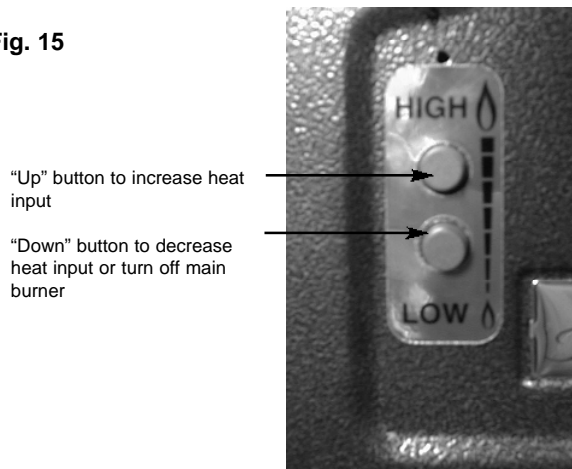

**NOTE :** The touch control does not light the pilot, it only lights the main burner when the pilot flame is established and regulates the heat input between high and low.

f) Check that the gas pressure is **20.0 mbar (+/- 1.0mbar) 8.0 in w.g.(+/- 0.4 in w.g.)** with the main burner operating on “high”.

**To turn off the main burner :-**

g) Turn right hand control knob clockwise to the position marked ● or press the down button on the remote handset until the flame extinguishes, at this point a clicking noise will be heard from the motor.

**To turn off the pilot flame :-**

h) Turn left hand control knob clockwise to the position marked ● and the pilot flame will extinguish.

i) After ensuring that the fire is safe to use it should be left on high position to fully warm up. During this time a slight odour may be noticed, this is due to the “newness” of the fire and will soon disappear.



**AFTER THE PILOT FLAME HAS BEEN EXTINGUISHED, IF YOU WISH TO RE-LIGHT THE APPLIANCE YOU MUST WAIT AT LEAST FIVE MINUTES BEFORE TRYING TO RE-LIGHT THE APPLIANCE.**

Finally, hand the Installation and Maintenance Instructions and the Users Instructions over to the customer and explain the operation of the fire.

**NOTE : THIS APPLIANCE IS DESIGNED TO WORK SAFELY AND EFFECTIVELY DURING ADVERSE WEATHER CONDITIONS. HOWEVER, DURING SUCH TIMES FLAME DISTURBANCE MAY BE NOTICED. THIS IS NORMAL AND DOES NOT EFFECT OR IMPAIR THE SAFETY OF THE APPLIANCE.**

### **3.3 FITTING OF THE FENDER**

**Warning : Please take care whilst handling the fender as it's cast iron construction means it is a heavy item that can be difficult to manoeuvre**

- a) Fit the fender by locating the two retaining brackets on the fender into the slotted channel on the front of the combustion chamber

### **3.4 FITTING OF THE CANOPY**

**Warning : Please take care whilst handling the canopy as it's cast iron construction means it is a heavy item that can be difficult to manoeuvre**

- a) The canopy is held in position by two off retaining screws at each side.
- b) Fig. 16 below shows the position of the retaining screws for the canopy

**Fig. 16**

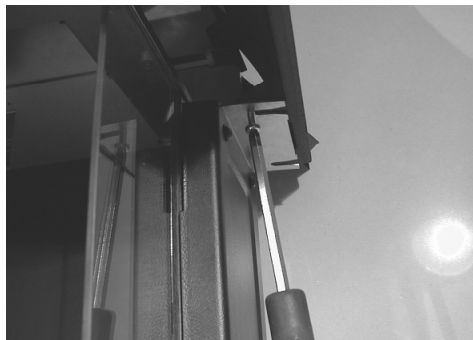

## **SECTION 4 MAINTENANCE**

### **Servicing Notes**

**Servicing should be carried out annually by a competent person such as a CORGI registered engineer. It is a condition of Flavel Fires 2 year guarantee scheme that this is carried out by a competent person i.e a CORGI registered Engineer in accordance with these servicing notes. The condition of the ceramic coal forms should be checked and if necessary the whole set should be replaced with a genuine replacement set. After any servicing work a gas tightness check must always be carried out.**

#### **4.1 Removing the Burner Assembly from the fire.**

- 4.1.1 Isolate the gas supply.
- 4.1.2 Remove fender from the front of the fire, as described in section 3.3 on page 17
- 4.1.3 Remove the glass frame assembly from the fire, as shown in section 2.8 on page 13.
- 4.1.4 Remove the ceramic coal forms from the combustion chamber taking care not to damage them.
- 4.1.5 Remove the two M4 burner retaining screws, located at the front of each end of the burner.
- 4.1.6 Slide the burner off the rear injector and remove from the product.

#### **4.2 Removing the Control Valve from the fire.**

- 4.2.1 Isolate the gas supply.
- 4.2.1 Remove the fender as described in section 3.3, on page 17
- 4.2.2 Disconnect the pipe to the bulkhead fitting on the valve and disconnect the pipe on the valve which runs to the inlet elbow.
- 4.2.3 Loosen the pilot pipe, disconnect the ignition lead from the electrode and disconnect the thermocouple from the pilot assembly.
- 4.2.5 Remove the 2 off fixing screws which hold the valve mounting plate to its mounting bracket and lift the valve and its mounting plate away from the combustion chamber.

4.2.6 Swap the valve mounting plate onto the new valve by unscrewing the two M5 nuts and bolts holding it in position .

4.2.7 Re-assemble with new valve in reverse order.

### **4.3 Removing the Battery Pack**

4.3.1 Disconnect the wire from the battery pack, located at the bottom L/H/S of the combustion chamber.

4.3.2 Lift the battery pack out of its mounting cradle.

4.3.3 Re-fit the new battery pack in its cradle and re-fit the wire.

### **4.4 Removing the Pilot Assembly**

4.4.1 Isolate the gas supply

4.4.2 Remove the fender as described in section 3.3, on page 17

4.4.3 Remove the glass frame assembly from the fire, as shown in section 2.8 on page 13.

4.4.4 Remove the ceramic coal forms from the combustion chamber taking care not to damage them.

4.4.5 Loosen the pilot pipe, disconnect the ignition lead from the electrode, and remove the thermocouple from the pilot body.

4.4.6 Remove the two fixing screws which secure the pilot assembly to the pilot mounting panel in the base of the combustion chamber.

4.4.7 Remove the pilot assembly.

4.4.8 Re-assemble with an new pilot assembly, and gasket, ensuring that an even seal around the pilot assembly is obtained. Carry out a gas tightness test after re-assembly.

### **4.5 Replacing the Touch Control Switch**

4.5.1 Remove the right hand side panel from the fire. Remove the touch control switch by releasing the nuts that hold it in position on the inside face.

4.5.2 Remove the connecting wires from the top left hand side of the control valve.

4.5.2 Fit new switch and re-assemble in reverse order

#### **PARTS SHORTLIST**

Replacement of any other parts must be carried out by a competent person such as a CORGI registered gas installer. The part numbers of the main replaceable parts are as follows, these are available from your local Flavel Stockist, whose details can be found on the CFM Europe website, in the "stockist" section.

Control Valve	B-82290	Pilot Body	70-36250
Thermocouple	70-36270	Pilot Gasket	70-35220
Ignition Electrode	70-36290	Ceramic / Coal Set	FC-P086110

**Due to our policy of continual improvement and development the exact accuracy of illustrations and descriptions contained in this book cannot be guaranteed**

**Part No. B-86710  
Issue 2**



CFM Europe Ltd.  
Trentham Lakes  
Stoke-on-Trent  
Staffordshire  
ST4 4TJ

[www.cfm-europe.com](http://www.cfm-europe.com)

**Telephone - Service :**

**(08700) 101187**

