

micro **GENUS**

Servicing Instructions

Type C Boilers

G.C.N: 47-116-14
47-116-15

LEAVE THESE INSTRUCTIONS
WITH THE END-USER



*The code of practice for the installation,
commissioning & servicing of central heating systems*

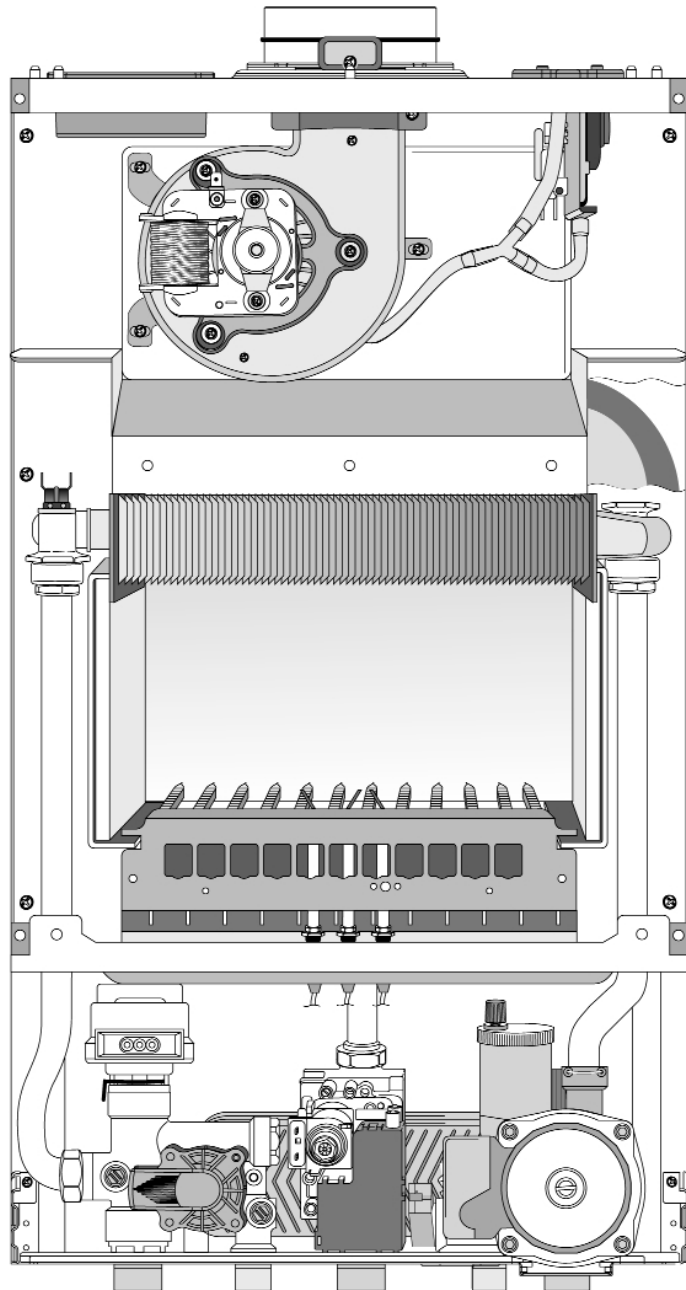

 **ARISTON**

TABLE OF CONTENTS

1. **SERVICING INSTRUCTIONS**
 - 1.1 REPLACEMENT OF PARTS
 - 1.2 TO GAIN GENERAL ACCESS
 - *Removing the front panel*
 - *Removing the sealed chamber frontal cover*
 - *Removing the side panels*
 - 1.3 ACCESS TO THE COMBUSTION CHAMBER
 - *Removing the combustion cover*
 - *Removing the burner and jets*
 - *Removing the electrodes*
 - *Removing the main heat exchanger*
 - *Removing the air pressure switch*
 - *Removing the fan*
 - *Removing the venturi device*
 - 1.4 SERVICING AND REMOVAL OF THE GAS VALVE
 - *Setting the gas pressures*
 - *Removing the spark generator*
 - *Removing the gas valve*
 - 1.5 ACCESS TO THE WATER CIRCUIT
 - *Removing the D.H.W. (secondary) exchanger*
 - *Removing the safety valve*
 - *Removing the automatic air vent*
 - *Removing the main circuit flow switch*
 - *Removing the pump*
 - *Removing the pressure gauge*
 - *Removing the expansion vessel*
 - *Removing the overheat thermostat*
 - *Removing the heating temperature sensor (N.T.C.)*
 - *Removing the D.H.W. temperature sensor (N.T.C.)*
 - *Removing the divertor valve actuator*
 - *Removing the D.H.W. flow switch*
 - 1.6 ACCESS TO THE CONTROL SYSTEM
 - *Checking the fuses*
 - *Removing the time clock*
 - *Removing the P.C.B.*
2. **FAULT FINDING**
 - 2.1 FAULT FINDING GUIDE (FLOW-CHART)
3. **ELECTRICAL DIAGRAMS**
4. **SHORT SPARE PARTS LIST**

1. SERVICING INSTRUCTIONS

To ensure efficient safe operation, it is recommended that the boiler is serviced annually by a competent person.

Before starting any servicing work, ensure both the gas and electrical supplies to the boiler are isolated and the boiler is cool.

Before and after servicing, a combustion analysis should be made via the flue sampling point (please refer to the Installation Manual for further details).

After servicing, preliminary electrical system checks must be carried out to ensure electrical safety (i.e. polarity, earth continuity, resistance to earth and short circuit).

1.1 REPLACEMENT OF PARTS

The life of individual components varies and they will need servicing or replacing as and when faults develop. The fault finding sequence chart in chapter 2 will help to locate which component is the cause of any malfunction, and instructions for removal, inspection and replacement of the individual parts are given in the following pages.

1.2 TO GAIN GENERAL ACCESS

All testing and maintenance operations on the boiler require the control panel to be lowered. This will also require the removal of the casing.

Removing the front panel

1. Loosen the fastening screws "A" of the control panel located on the lower part of the panel itself. (FIG. 1.1);

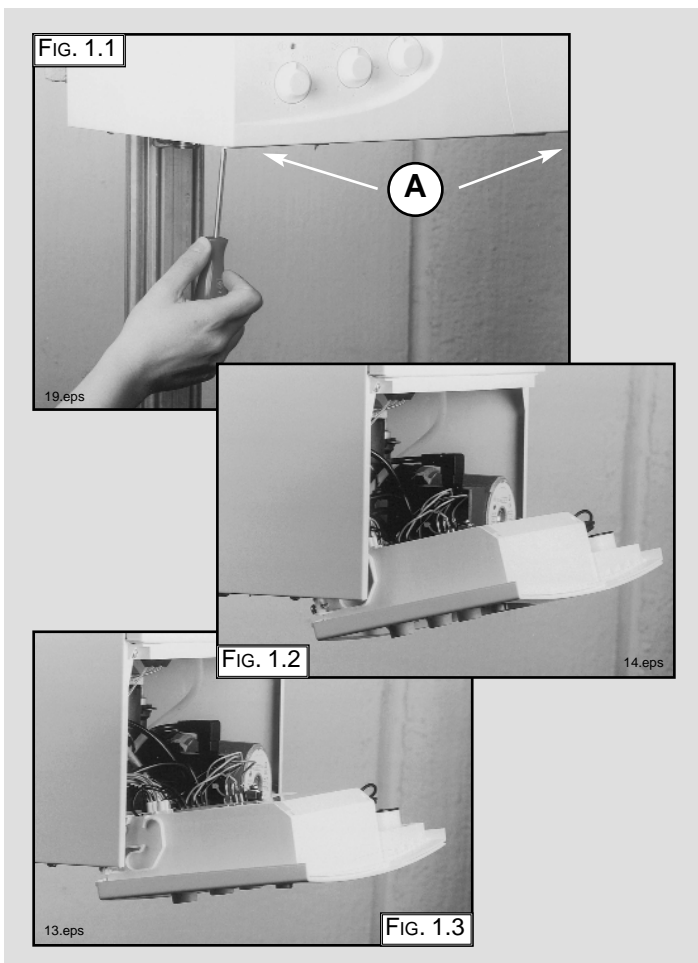

2. The control panel moves downward and when pulled forward, rotates on two lateral hinges; the panel stays in a semi-horizontal position, which allows access to the inner parts of the boiler (FIG. 1.2);
3. In order to increase the manouvering space, it is possible to raise the control panel and rotate it to a fully horizontal position (FIG. 1.3);
4. Remove the screws "B" from the front panel bottom lip (FIG. 1.4);
5. Lift the front panel from the raised screws at the the top of the casing (FIG. 1.5).

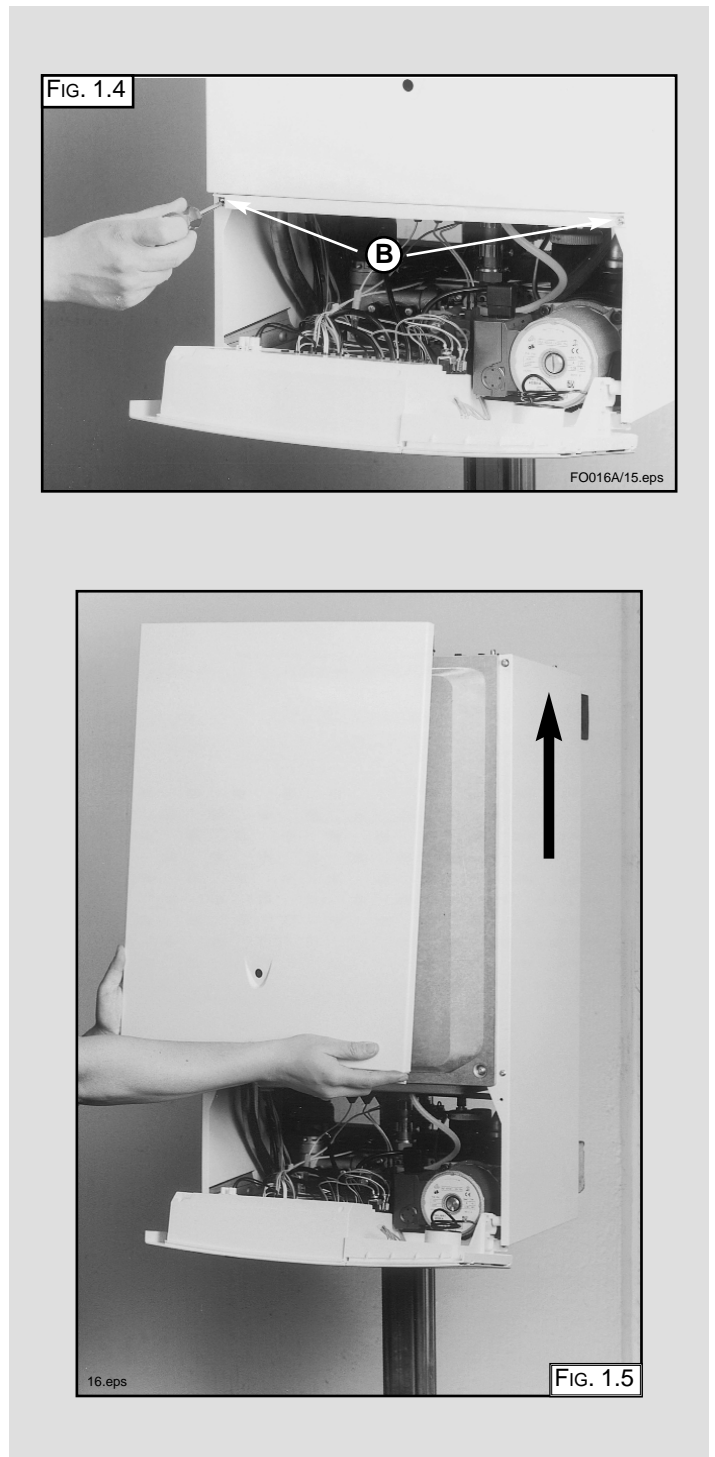

Removing the sealed chamber frontal cover

1. Remove the screws "C" (FIG. 1.6);
2. Lift the sealed chamber frontal cover from the locating pins (FIG. 1.7).

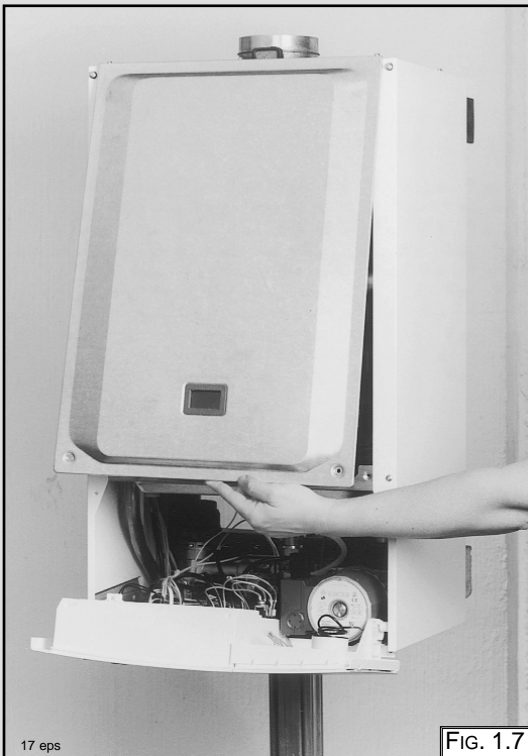
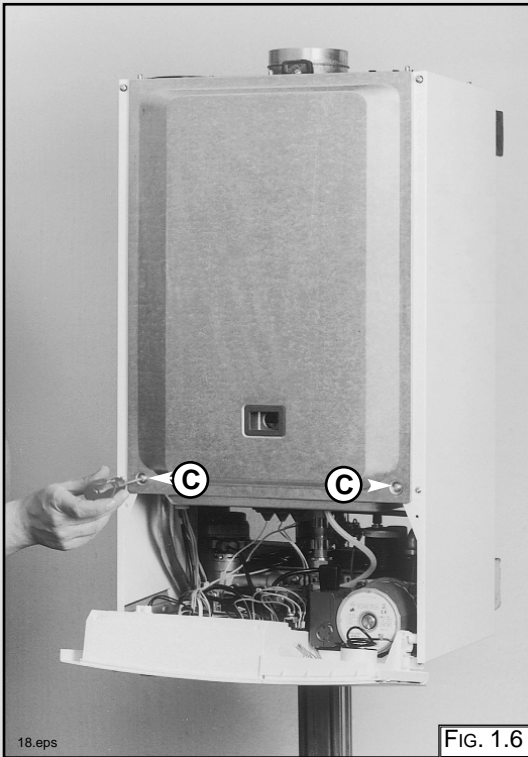

Removing the side panels

1. Remove the four screws "D" for each side panel (FIG.1.8);
2. Pull the panel away from the boiler, then lift the panel up and remove from the boiler (FIG.1.9).

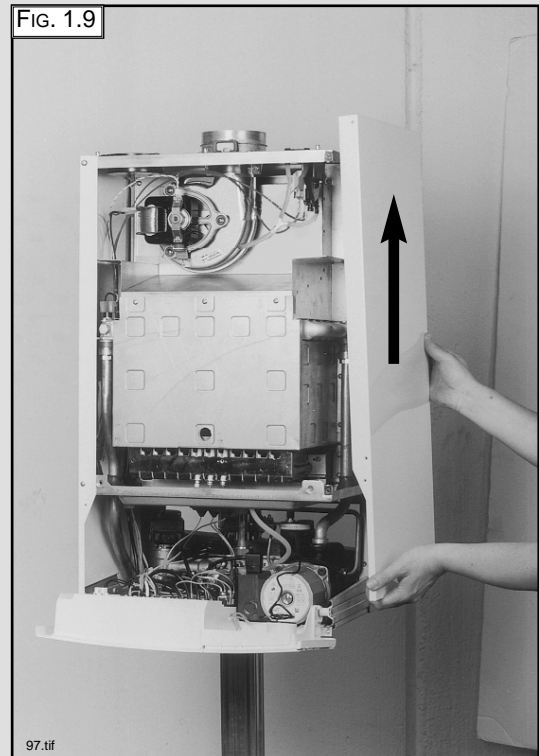
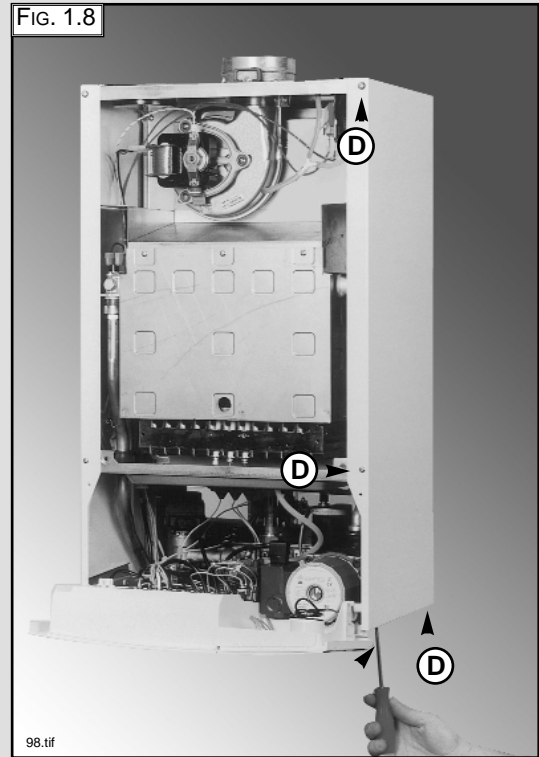

1.3 ACCESS TO THE COMBUSTION CHAMBER

Removing the combustion cover

1. Remove the screws "E" (FIG. 1.10);
2. Lift off the combustion cover.

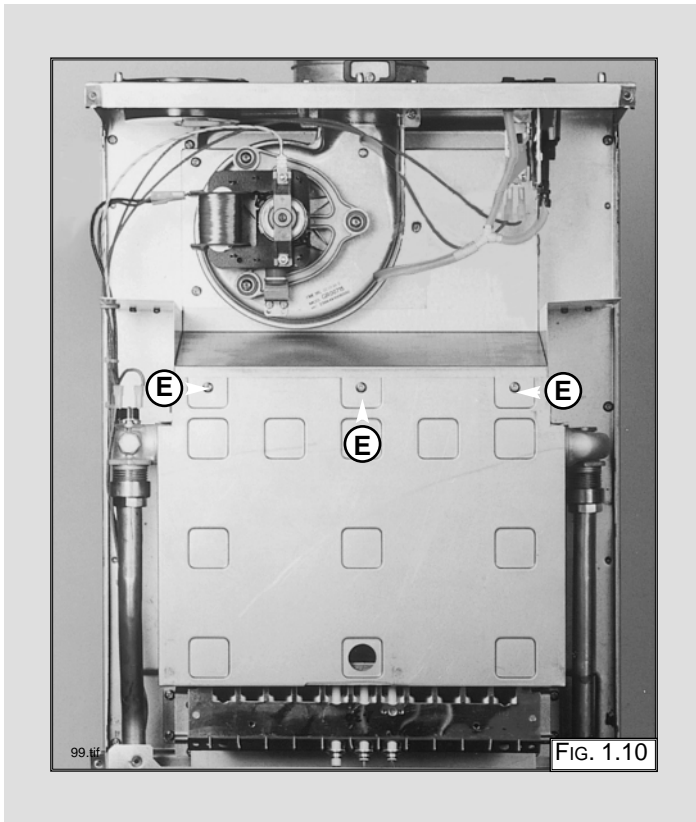

Removing the burner and jets

1. Remove the screws "F" from the burner (FIG. 1.11);
2. Remove the burner (FIG. 1.12);
3. Remove the jets using a No. 7 socket spanner;
4. Replace in reverse order.

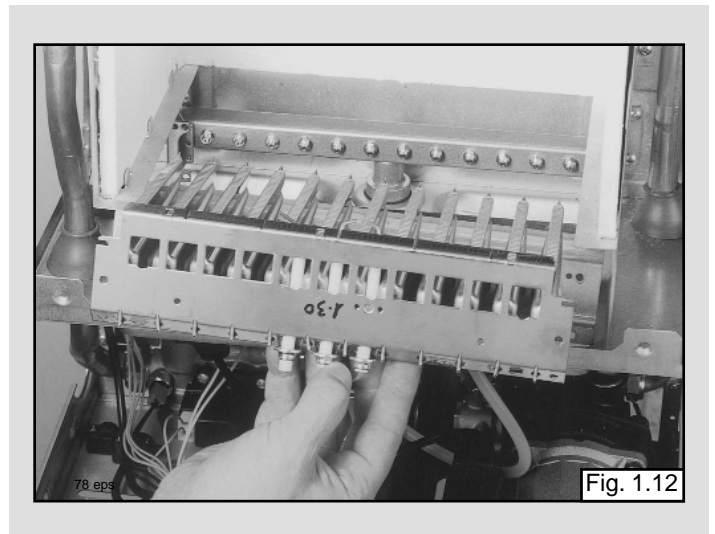
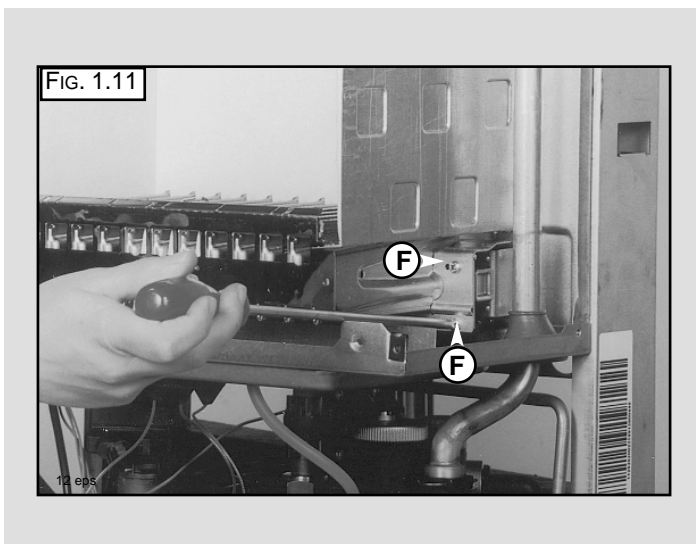

Removing the electrodes

Before carrying out this procedure, unscrew and slide the burner forward (see previous section).

1. Remove rubber gasket "G" (FIG. 1.13);
2. To remove the detection electrode disconnect the cable at its connection point close to the P.C.B. (FIG. 1.14);

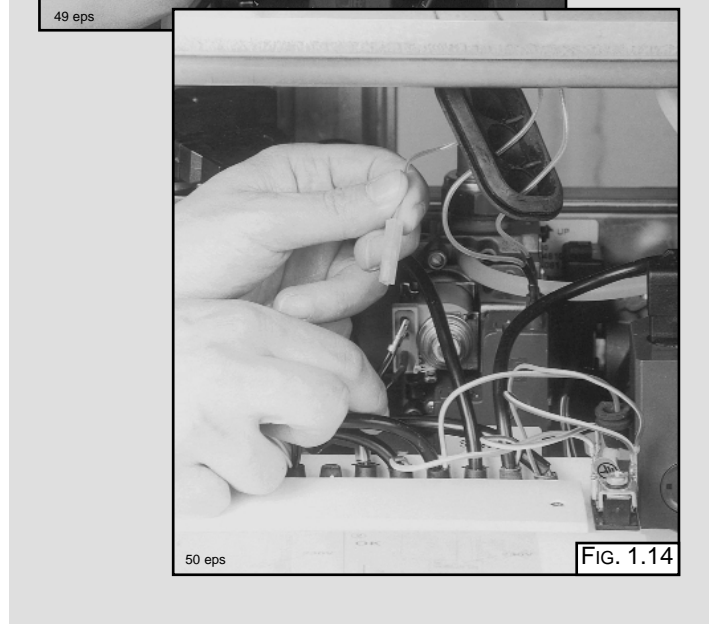
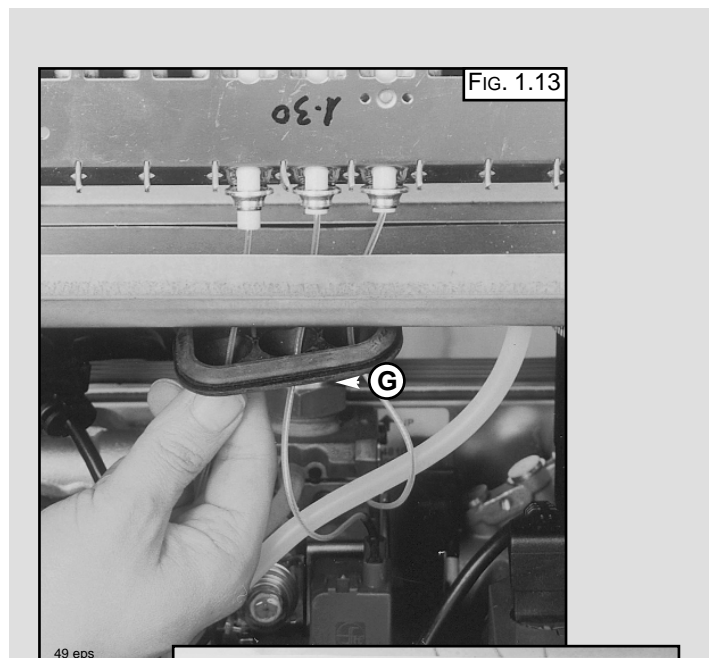

3. Remove screw "H" (FIG. 1.15);
4. Gently slide the electrode downward (FIG. 1.16).

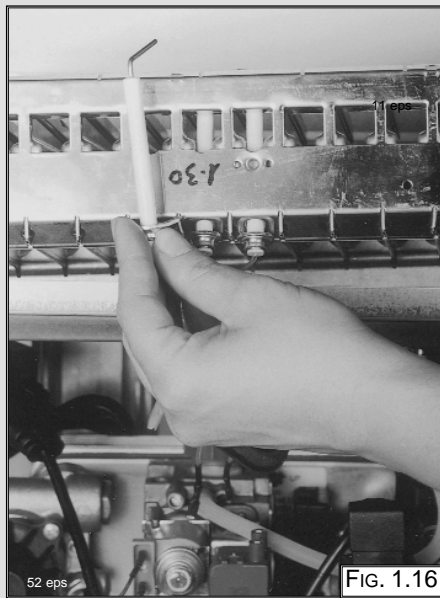
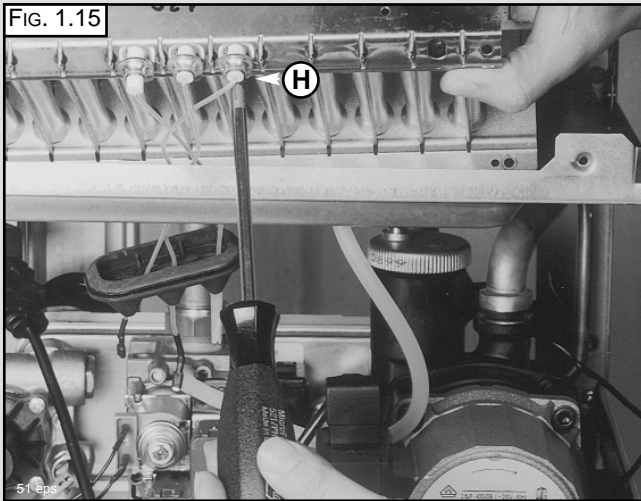

Removing the main heat exchanger

1. Drain the boiler of water;
2. Release the overheat thermostat sensor "I" (FIG. 1.17);
3. Release the two connection nuts "J" connecting the exchanger to the flow and return pipes (FIG. 1.18);
4. Pull it straight out (FIG. 1.19).

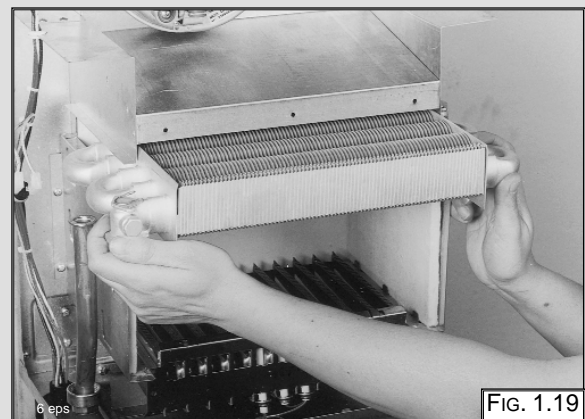
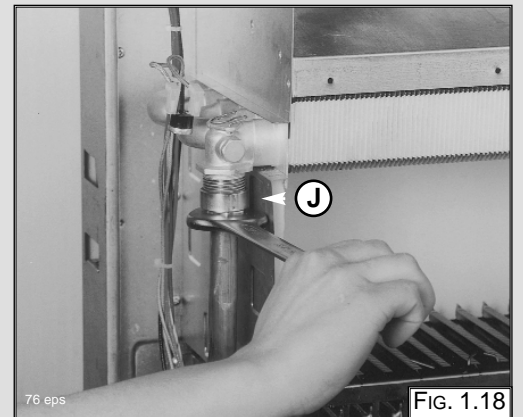
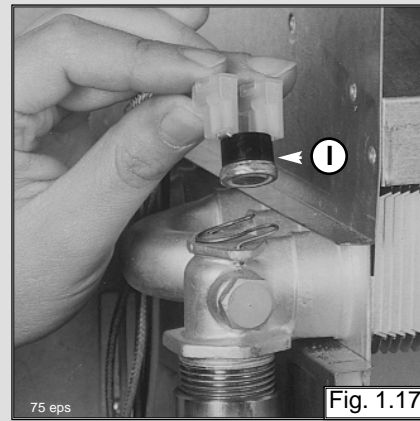

To replace, repeat the steps in reverse order, paying particular attention to the following:

- a** - Centre the electrode in the positioning hole carefully, otherwise the electrode may break;
- b** - Check that the cables have been connected correctly;
- c** - Check that the rubber gasket covers the cable/ electrode connection point completely.

Removing the air pressure switch

1. Disconnect the electrical connections "K" and silicon pipes "L" from their connection points (FIG. 1.20);
2. Remove screws "M" on the top of the sealed chamber (FIG. 1.21);
3. Unscrew to remove switch from the plate (FIG. 1.22).

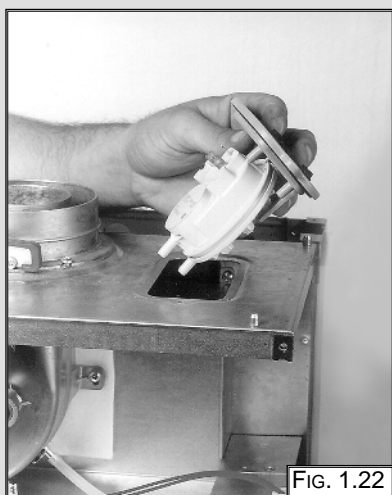
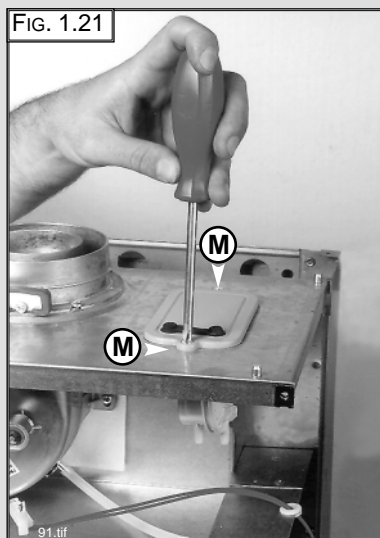
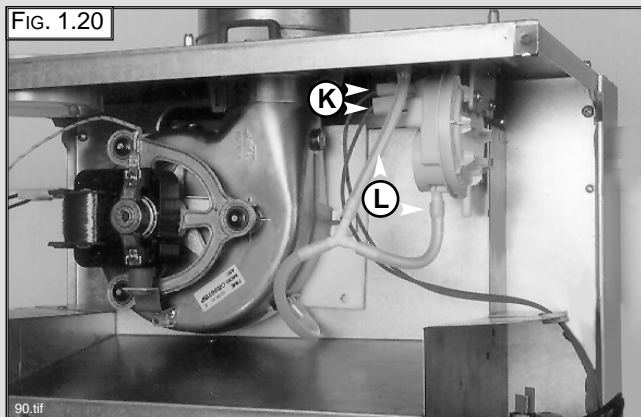

Removing the fan

1. Disconnect electrical connections "N" and silicon pipes "O" (FIG.1.23);
2. Remove screw "P" and remove the fan collar clamp "Q" (FIG.1.24);
3. Remove screws "R" (FIG.1.25);
4. Remove fan and mounting plate (FIG.1.26).

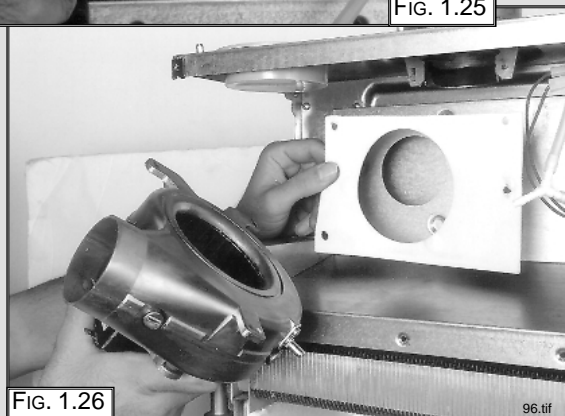
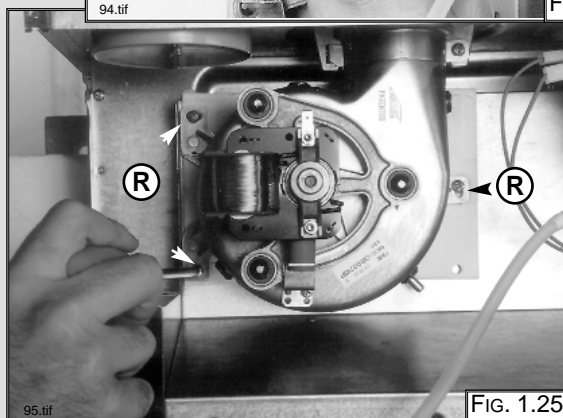
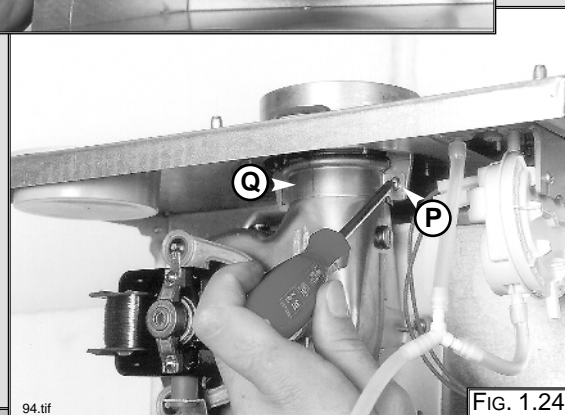
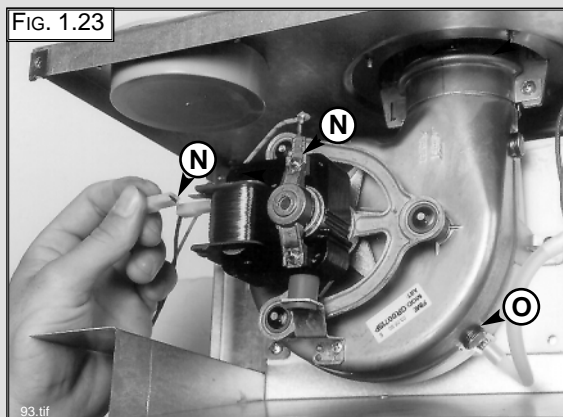

1.4 SERVICING AND REMOVAL OF THE GAS VALVE

Setting the gas pressures

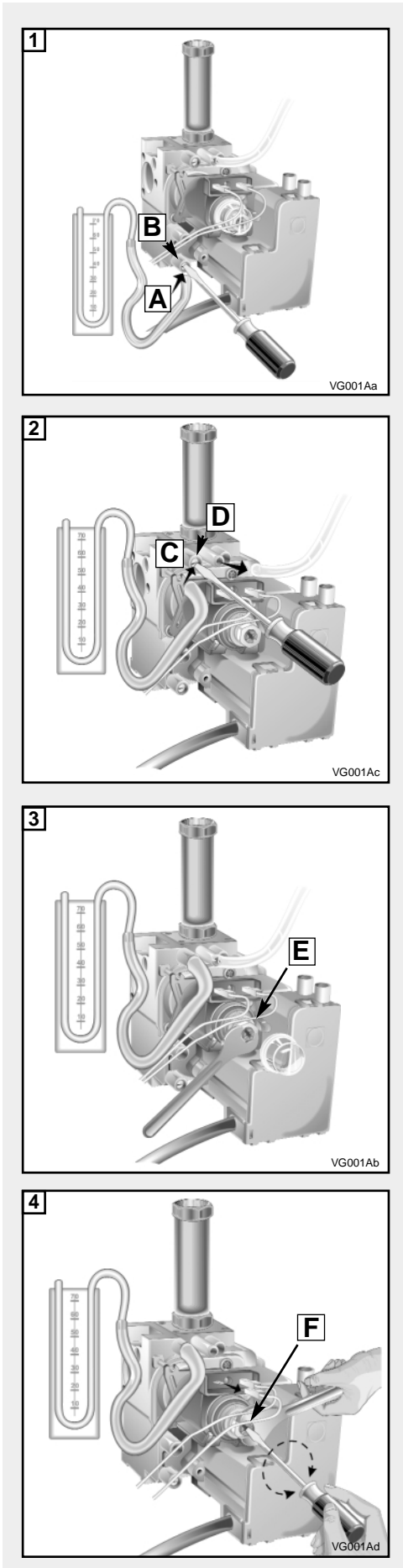

Setting the minimum and the maximum power of the boiler

1. Check that the supply pressure to the gas valve is a minimum of 20 mbar for natural gas.
2. To do this, remove the screw "A".
Fit the pipe of the pressure gauge to the pressure connection of the gas valve "B".
When you have completed this operation, replace the screw "A" securely into its housing to seal off the gas.
3. To check the pressure supplied by the gas valve to the burner, remove the screw "C". Fit the pipe of the pressure gauge to the pressure outlet of the gas valve "D".
Disconnect the compensation pipe either from the gas valve or from the sealed chamber.
4. Set the On/Off button to position < ① > and the "summer/winter" switch to the winter position.
To set the maximum power, turn on the hot water tap and allow the hot water tap to run at a rate of about 8 litres/minute so that the main burner lights.
Adjust nut "E" on the modereg to set the gas pressure (displayed on the pressure gauge) corresponding to the maximum power (see TABLE "A" page 9).
5. To set the minimum power, disconnect a supply terminal from the modereg and adjust screw "F".
Turn the screw clockwise to increase the pressure and counter-clockwise to decrease the pressure (displayed on the pressure gauge) corresponding to the minimum power (see TABLE "A" page 9).
6. When you have completed the above operations, turn off the hot water tap, re-connect the supply terminal to the modereg on the gas valve and replace the cap on the screw of the modereg.

Setting the maximum heating circuit power

7. To set the maximum heating circuit power, place the On/Off button to position < ① > and the "summer/winter" switch to winter position.
Turn the knob of the heating thermostat clockwise to maximum.
8. Remove the inspection panel of the P.C.B. and fit a small cross-head screwdriver in to the right hand potentiometer. Turn clockwise to increase the pressure or counter-clockwise to reduce the pressure. Adjust the setting to the required heating pressure value (displayed on the pressure gauge), as indicated in the diagrams shown in page 10.
9. Turn off the boiler by placing the main switch to the "Off" position.

Setting pressure for soft ignition.

Disconnect the detection electrode connection from the P.C.B..

Start the boiler and during the ignition sequence adjust the left hand potentiometer until the gas pressure reads the required gas pressure as per the table below.

Once the gas pressure is set turn off the boiler and re-connect the connection to the P.C.B.

NB.: It may be necessary to reset the flame failure reset a number of times during this operation.

	NATURAL GAS (G20)	BUTANE GAS (G30)	PROPANE GAS (G31)
Recommended pressure for soft-light ignition	8 mbar	16 mbar	16 mbar

Regulating the heating power for natural gas (G20)

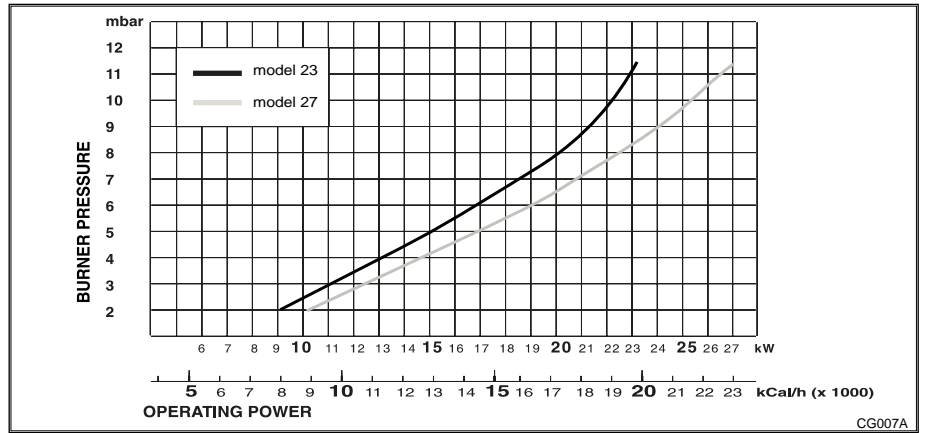

Regulating the heating power for butane gas (G30)

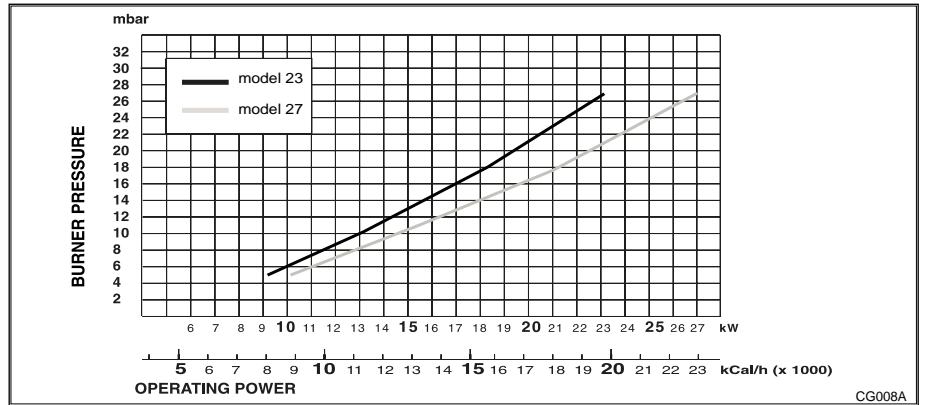

Regulating the heating power for propane gas (G31)

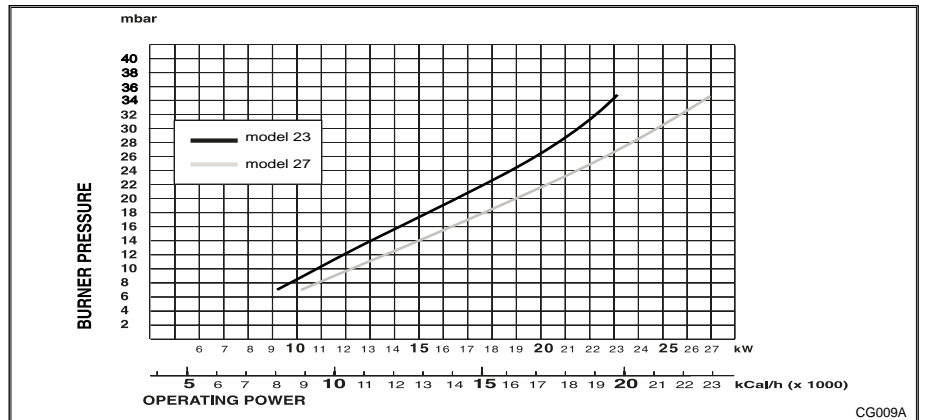
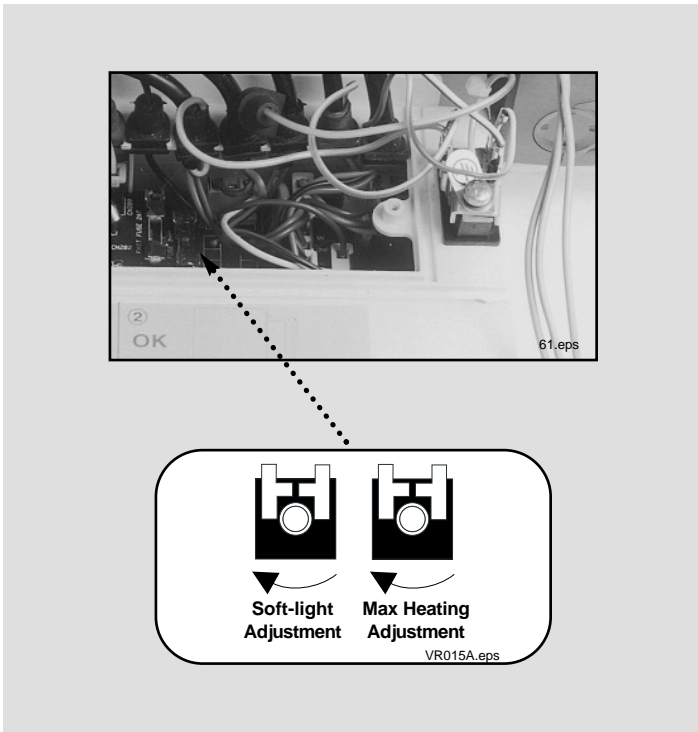

TABLE "A"

mife GENUS 23 MFFI	GAS REQUIREMENTS		NATURAL GAS (G20)	BUTANE GAS (G30)	PROPANE GAS (G31)
	Gas rate	max	2.70 m ³ /h	2.01 Kg/h	2.00 Kg/h
	Gas rate	min	1.16 m ³ /h	0.87 Kg/h	0.85 Kg/h
	Inlet pressure		20 mbar	28 mbar	37 mbar
	Burner pressure	max	11.0 mbar	27.7 mbar	35.5 mbar
	Burner pressure	min	2.0 mbar	6.0 mbar	7.3 mbar
	Burner jets		12 x 1.30	12 x 0.77	12 x 0.77
mife GENUS 27 MFFI	GAS REQUIREMENTS		NATURAL GAS (G20)	BUTANE GAS (G30)	PROPANE GAS (G31)
	Gas rate	max	3.15 m ³ /h	2.34 Kg/h	2.31 Kg/h
	Gas rate	min	1.26 m ³ /h	0.94 Kg/h	0.93 Kg/h
	Inlet pressure		20 mbar	28 mbar	37 mbar
	Burner pressure	max	11.0 mbar	27.7 mbar	35.5 mbar
	Burner pressure	min	1.6 mbar	4.6 mbar	6.0 mbar
	Burner jets		14 x 1.30	14 x 0.77	14 x 0.77



10. Remove the pipe from the pressure gauge and connect screw "C" to the pressure outlet in order to seal off the gas.
11. Carefully check the pressure outlets for gas leaks (valve inlet and outlet).

IMPORTANT!

Whenever you disassemble and reassemble the gas connections, always check for leaks using a soap and water solution.

Removing the spark generator

1. Disconnect ignition leads "T" by pulling upward (FIG. 1.27);
2. Remove the screw "V" (FIG. 1.28);
3. Remove the spark generator (FIG. 1.29).

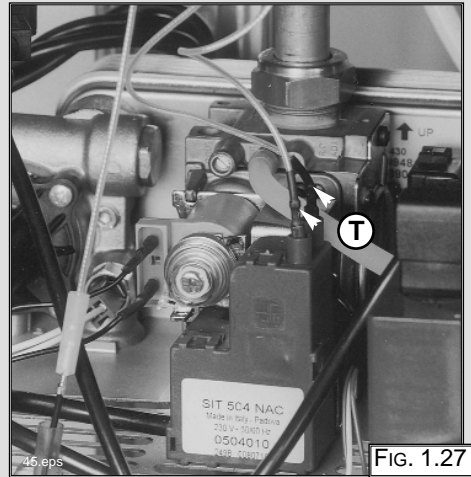

FIG. 1.27

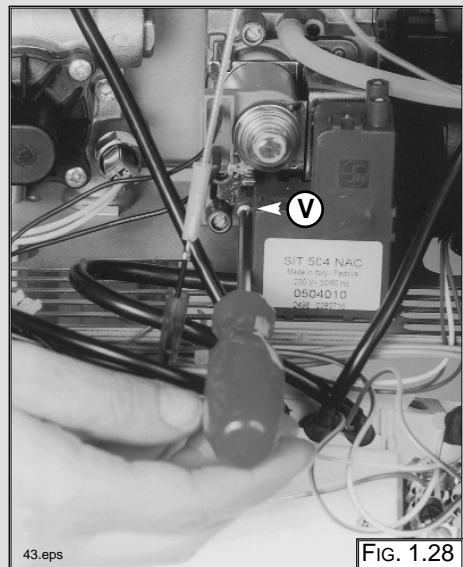

FIG. 1.28

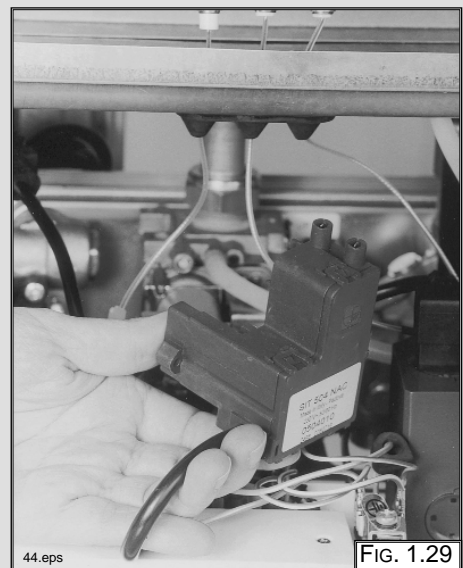
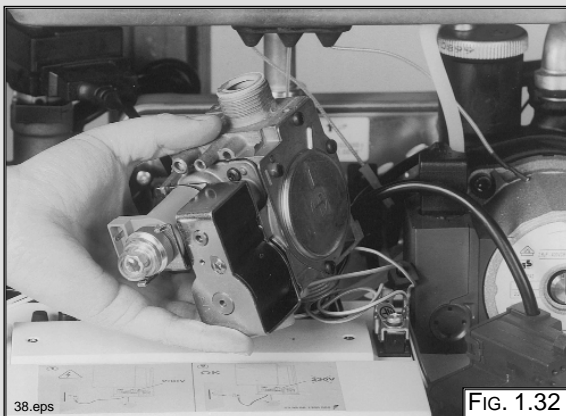
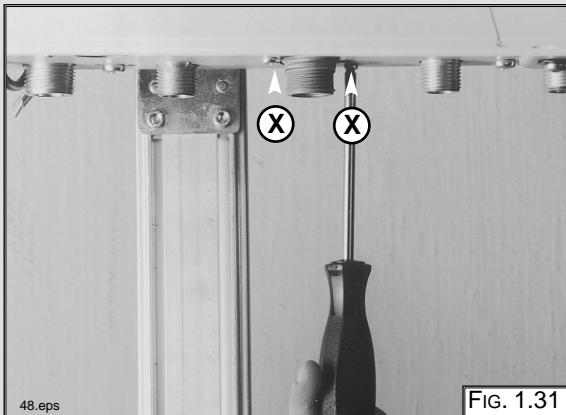
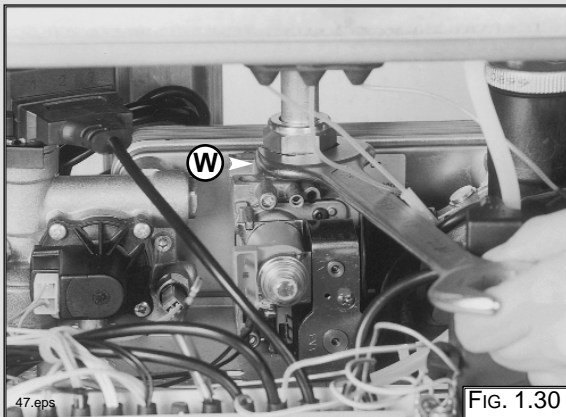

FIG. 1.29

Removing the gas valve

1. Disconnect all the cables from the solenoid and modureg;
2. Remove the spark generator (see previous section);
3. Release the top nut "W" (FIG. 1.30);
4. Remove the screws "X" from the bottom of the gas valve pipe (FIG. 1.31);
5. Remove the gas valve (FIG. 1.32).



1.6 ACCESS TO THE WATER CIRCUIT

Important! Before any component is removed, the boiler must be drained of all water.

Removing the D.H.W. (secondary) exchanger

1. Remove the screws "Y" (FIG 1.33 + FIG 1.34);
2. Push the exchanger towards the rear of the boiler, and lift upwards and remove out of the front of the boiler (FIG 1.35);
3. Before replacing the exchanger ensure that the O-rings are in good condition and replace if necessary.

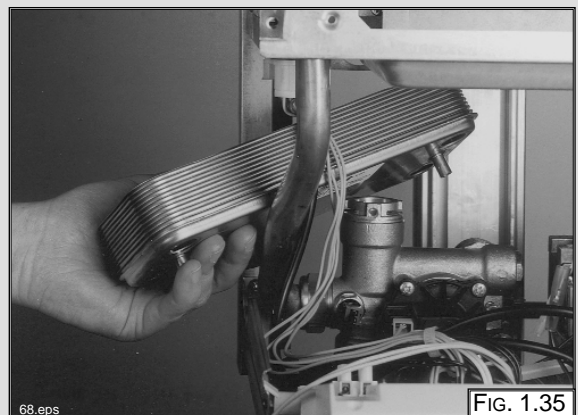
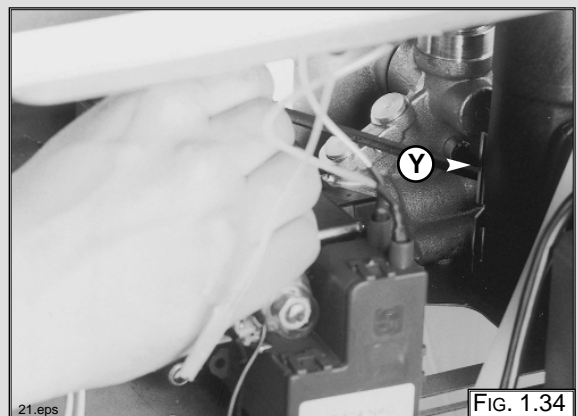
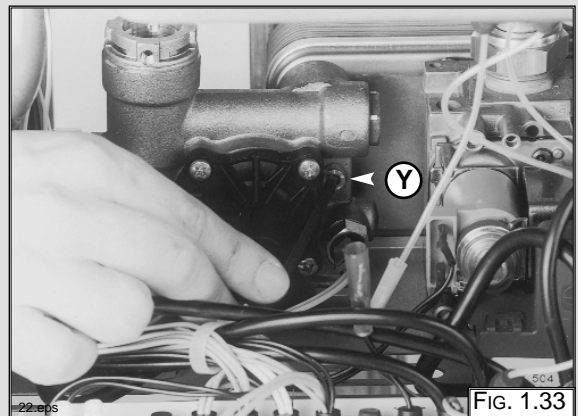

Removing the safety valve

1. Loosen nut "Z" (FIG. 1.36);
2. Unscrew and remove the valve (FIG. 1.37).

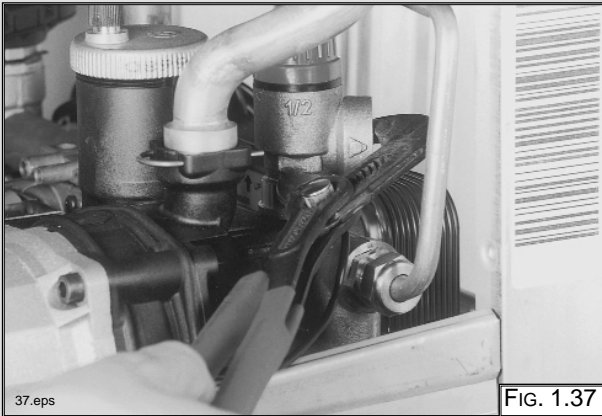
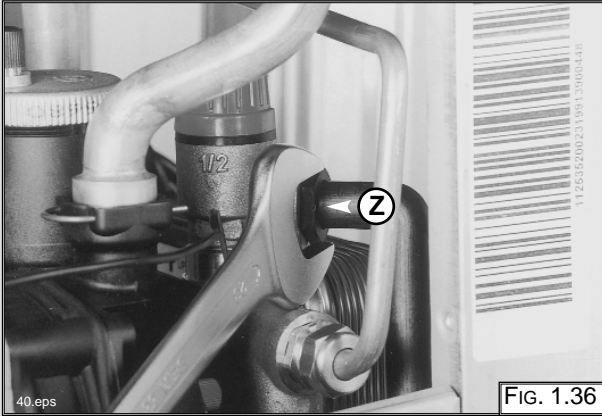

Removing the automatic air vent

1. Unscrew valve top "A1" (FIG. 1.38);
2. Remove valve (FIG 1.39).

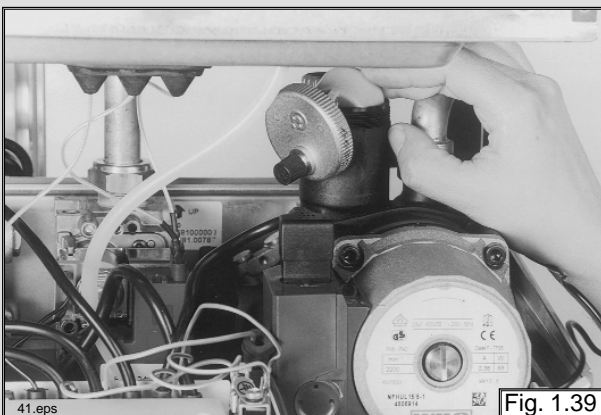
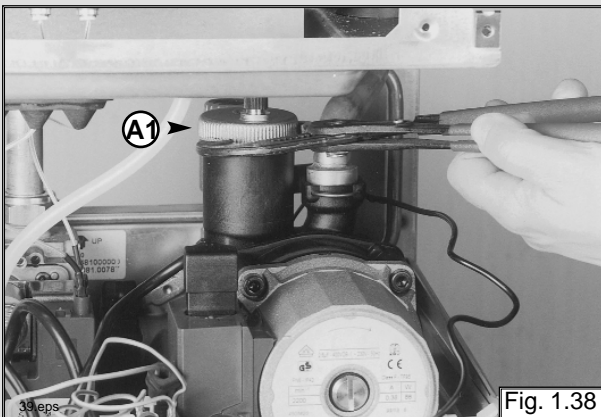

Removing the main circuit flow switch

1. Remove the cable of the main circuit flow switch "B1" (FIG. 1.40);
2. Remove the screws "C1" (FIG. 1.41);
3. Remove the main circuit flow switch.

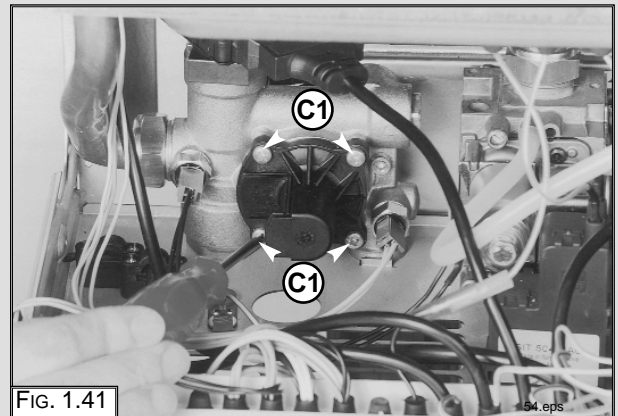
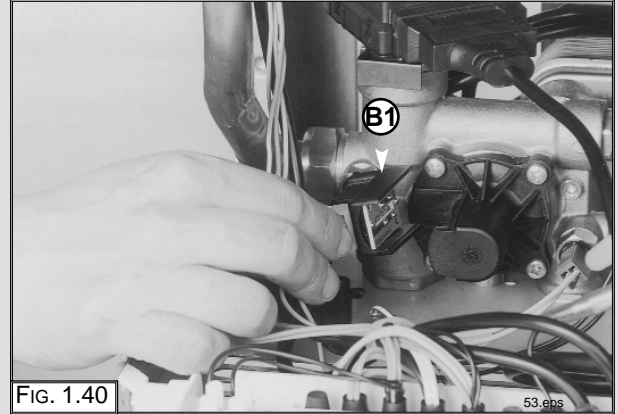

Removing the pump

1. Remove the U-clip "D1" (FIG. 1.41);
2. Remove the retaining clip "E1" (FIG. 1.42);
3. Remove the U-clip "F1" (FIG. 1.43);
4. Release the nut "G1" (FIG. 1.44);
5. Remove the pipe "H1" (FIG. 1.45);
6. Remove the screws "I1" (FIG. 1.46);
7. Remove the pump (FIG. 1.47).

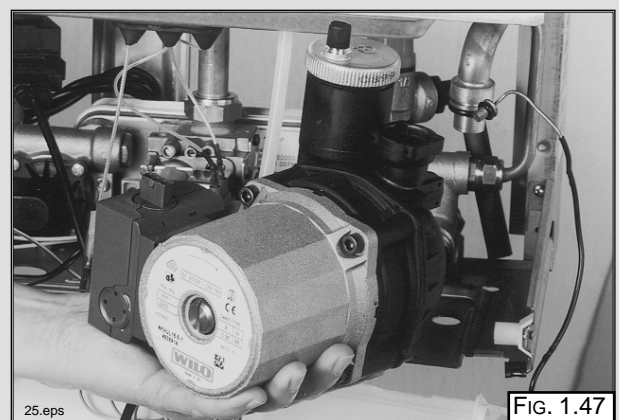
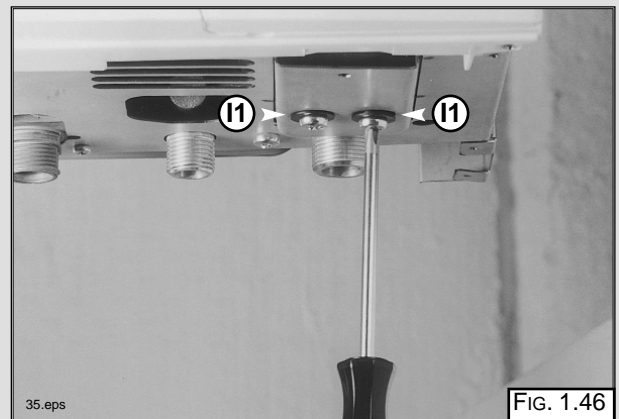
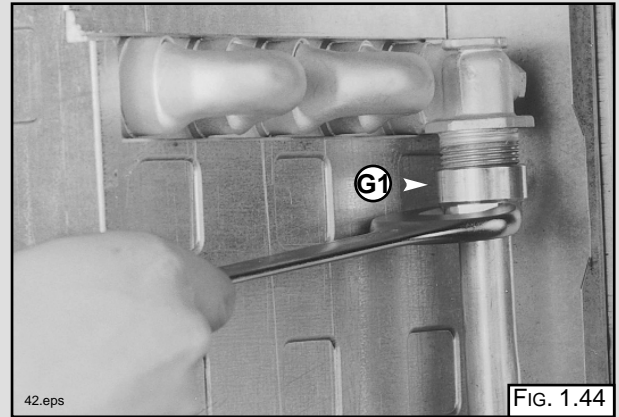
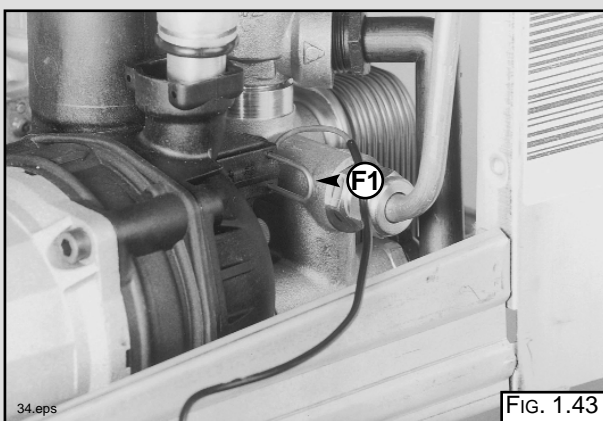
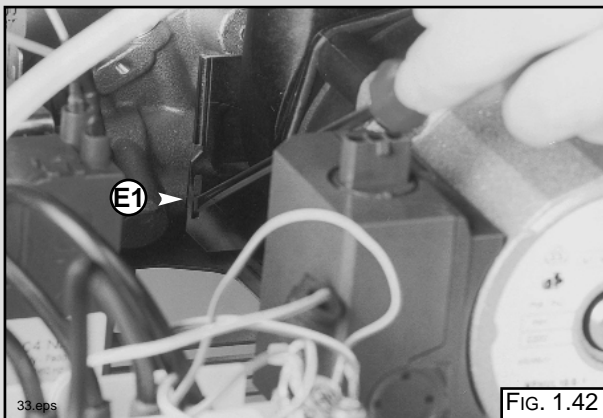
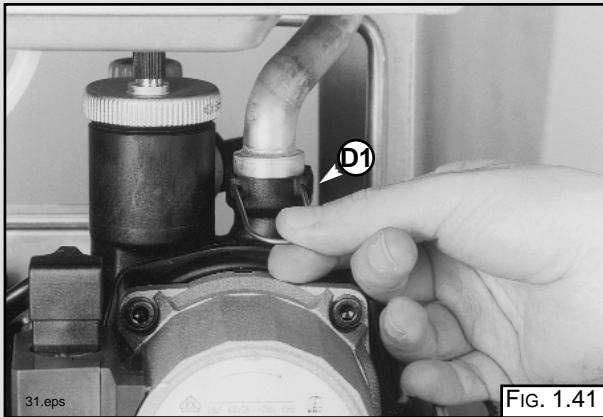

Removing the pressure gauge

1. Remove the U-clip "J1" and remove the pressure gauge coupling (FIG. 1.48);
2. Push the pressure gauge through the control panel from the rear (FIG. 1.49).

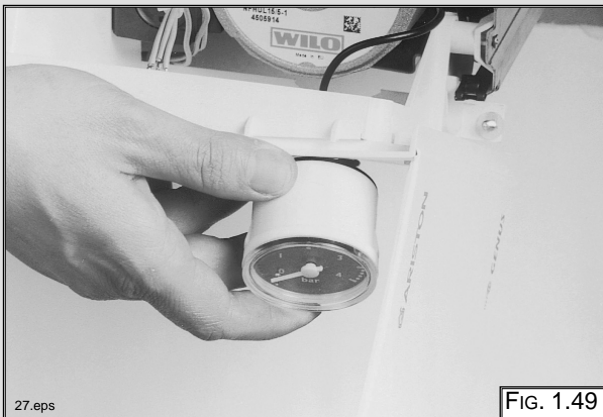
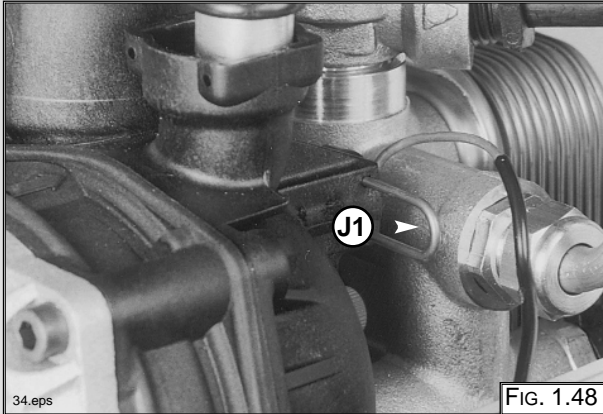

Removing the expansion vessel

1. Loosen nuts "K1" and remove the gas pipe (FIG. 1.50);
2. Loosen nut "L1" (FIG. 1.51);
3. Remove back nut "M1" (FIG. 1.52);
4. Remove the expansion vessel (FIG. 1.53).

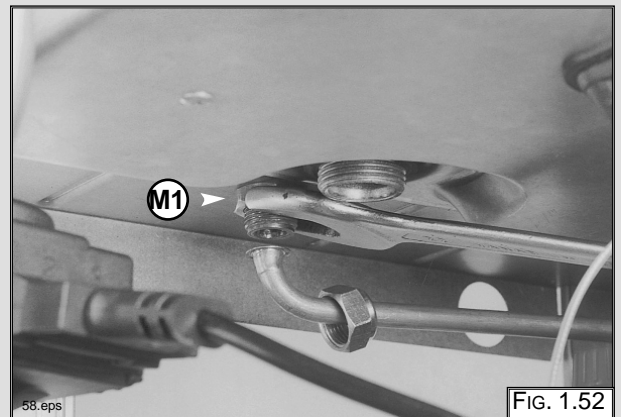
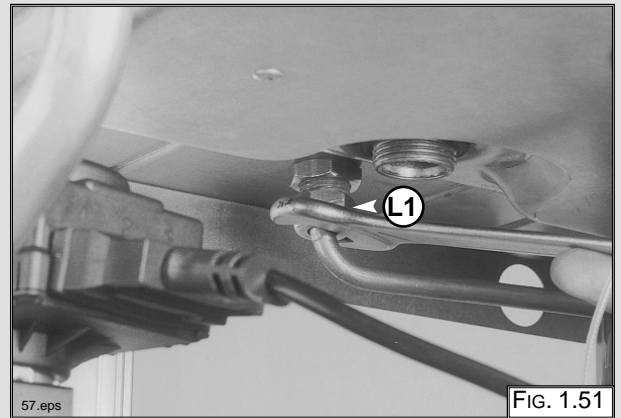
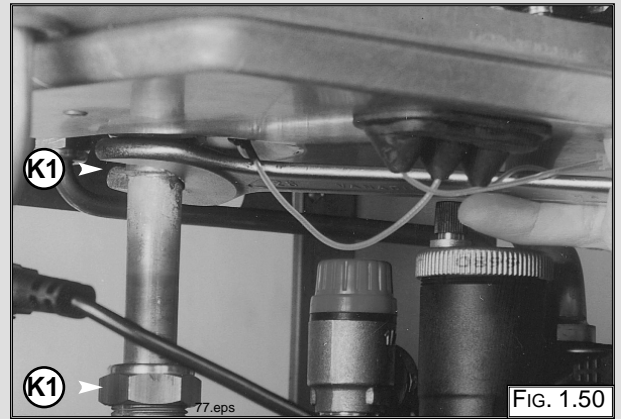

Removing the overheat thermostat

1. Disconnect the overheat thermostat electrical connections "N1" (FIG. 1.54);
2. Then remove the thermostat from its mounting by releasing the securing clip (FIG. 1.55).

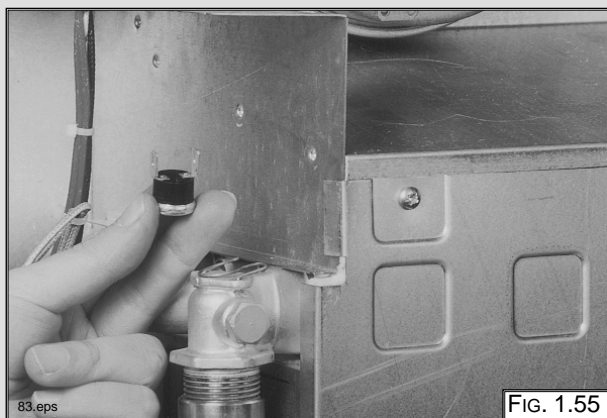
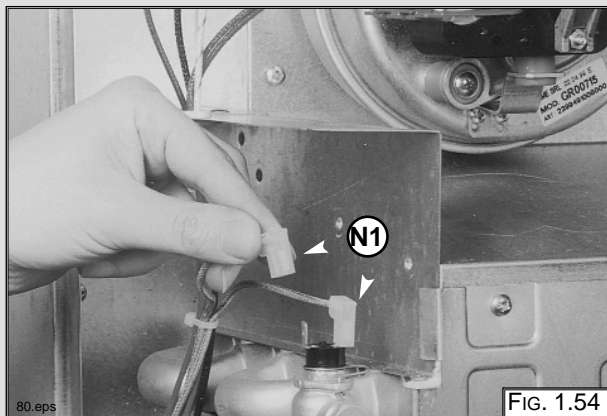

Removing the heating temperature sensor (N.T.C.)

1. Pull off the electrical connector "P1" and unscrew the sensor probe using a suitable spanner (FIG. 1.56).

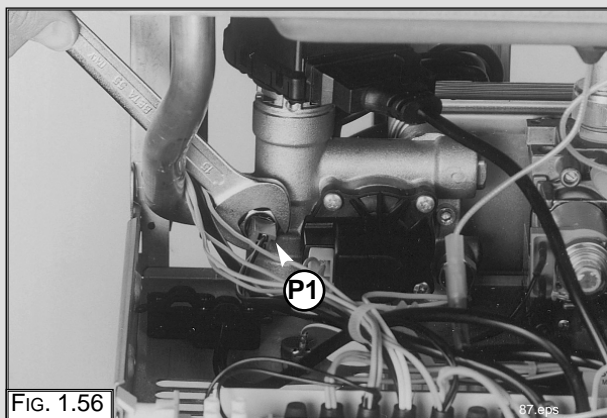

Removing the D.H.W. temperature sensor (N.T.C.)

1. Pull off the electrical connector "Q1" and unscrew the sensor probe using a suitable spanner (FIG. 1.57).

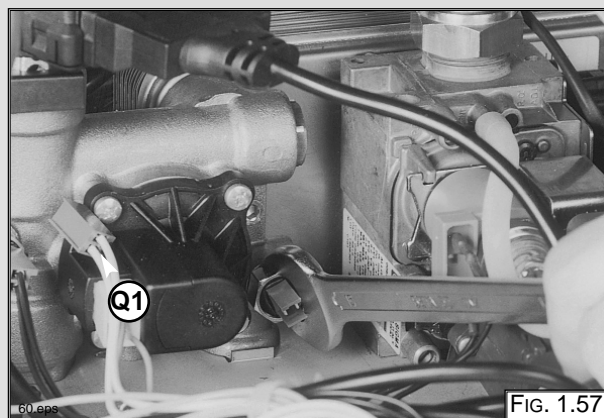

Removing the diverter valve actuator

1. Unplug the electrical connector "R1" (FIG. 1.58);
2. Release the retaining clip "S1" and remove the diverter valve actuator.

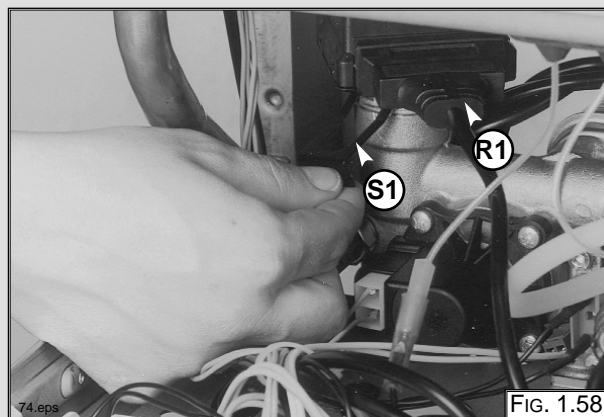

Removing the D.H.W. flow switch

1. Unplug the electrical connector "T1" (FIG. 1.59);
2. Release the retaining clip "V1" and remove the D.H.W. flow switch.

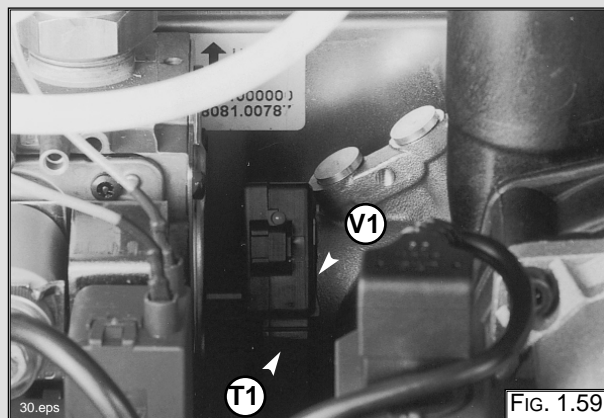

1.6 ACCESS TO THE CONTROL SYSTEM

Checking the fuses

1. Remove the inspection cover on the reverse of the control panel (FIG. 1.60);
2. Remove the fuses (FIG. 1.61).

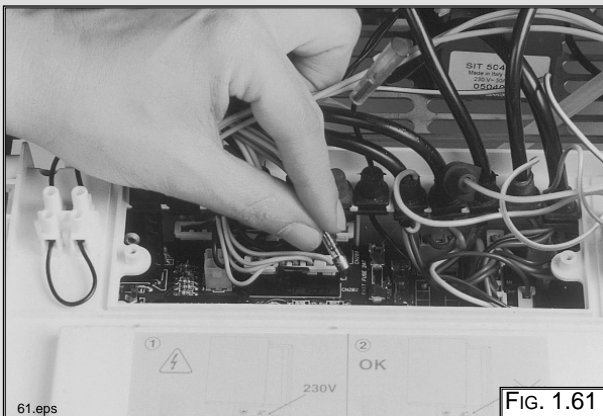
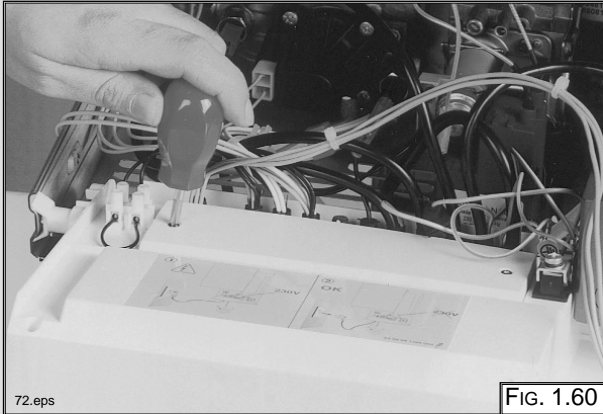

Removing the time clock

1. Unplug electrical connection "W1" from the clock (FIG. 1.62);
2. Remove the screws "W2" (see fig. 1.63);
3. Remove the clock from the panel (see fig. 1.64).

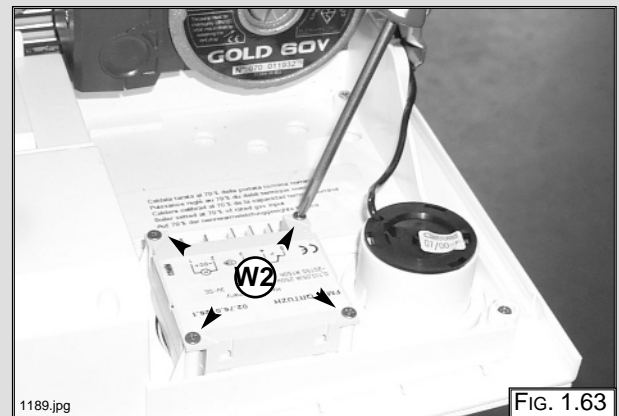

Removing the P.C.B.

1. Isolate electricity;
2. Remove the inspection cover from the reverse of the control panel;
3. Unplug all electrical connections from the P.C.B. (FIG. 1.65);
4. Remove the screws "X1" (FIG. 1.66);
5. Separate the fascia panel from the rear of the control panel (FIG. 1.67);
7. Remove the screws "Y1" and remove the P.C.B. (FIG. 1.68).

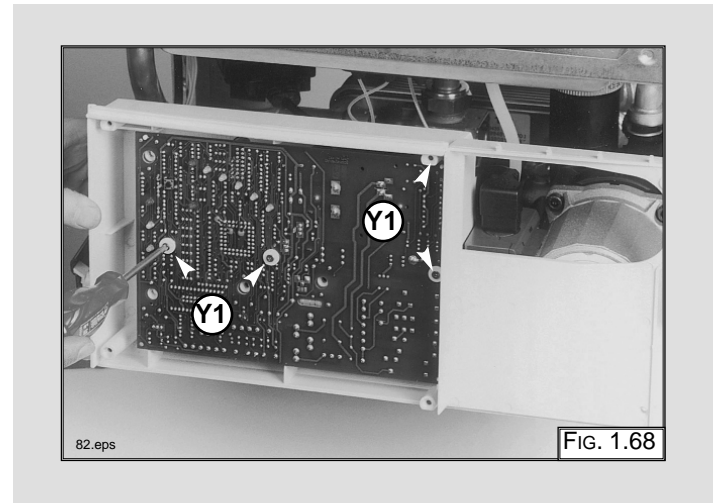
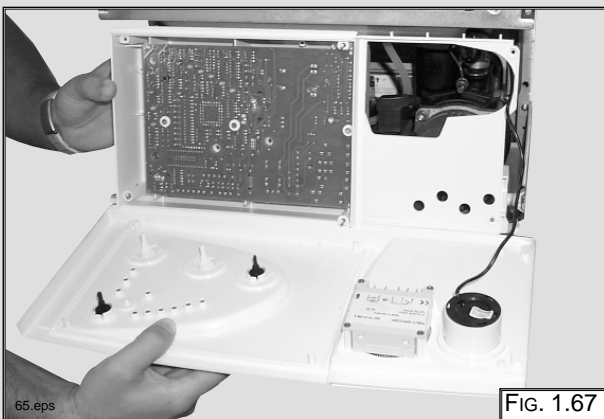
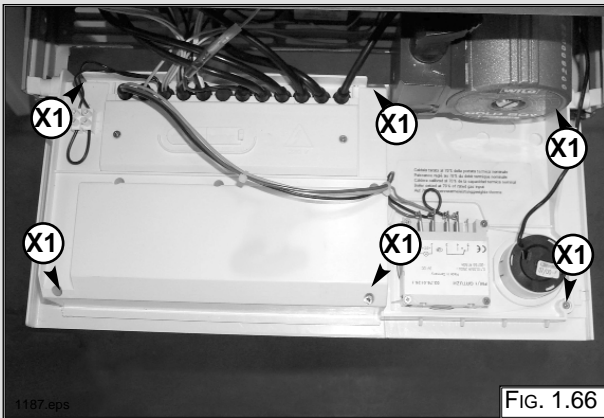
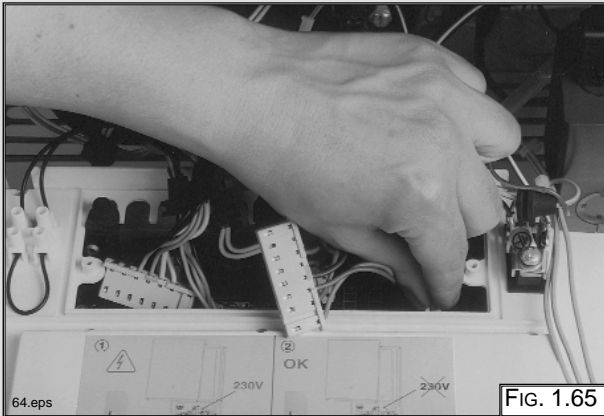

2. FAULT FINDING

2.1 FAULT FINDING GUIDE (FLOW-CHARTS)

It is possible to detect and correct any defect by using the standard fault finding diagrams described in this chapter.

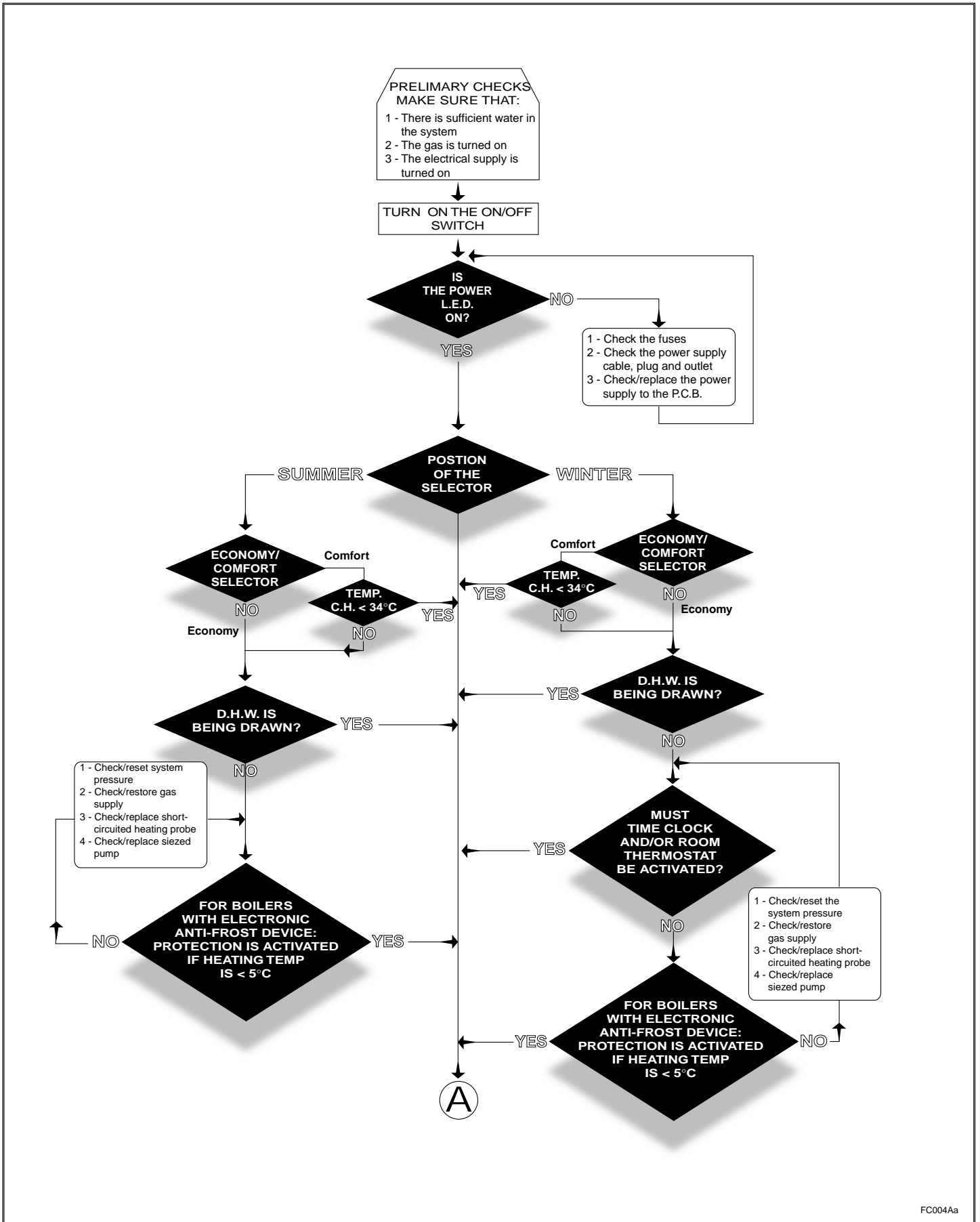

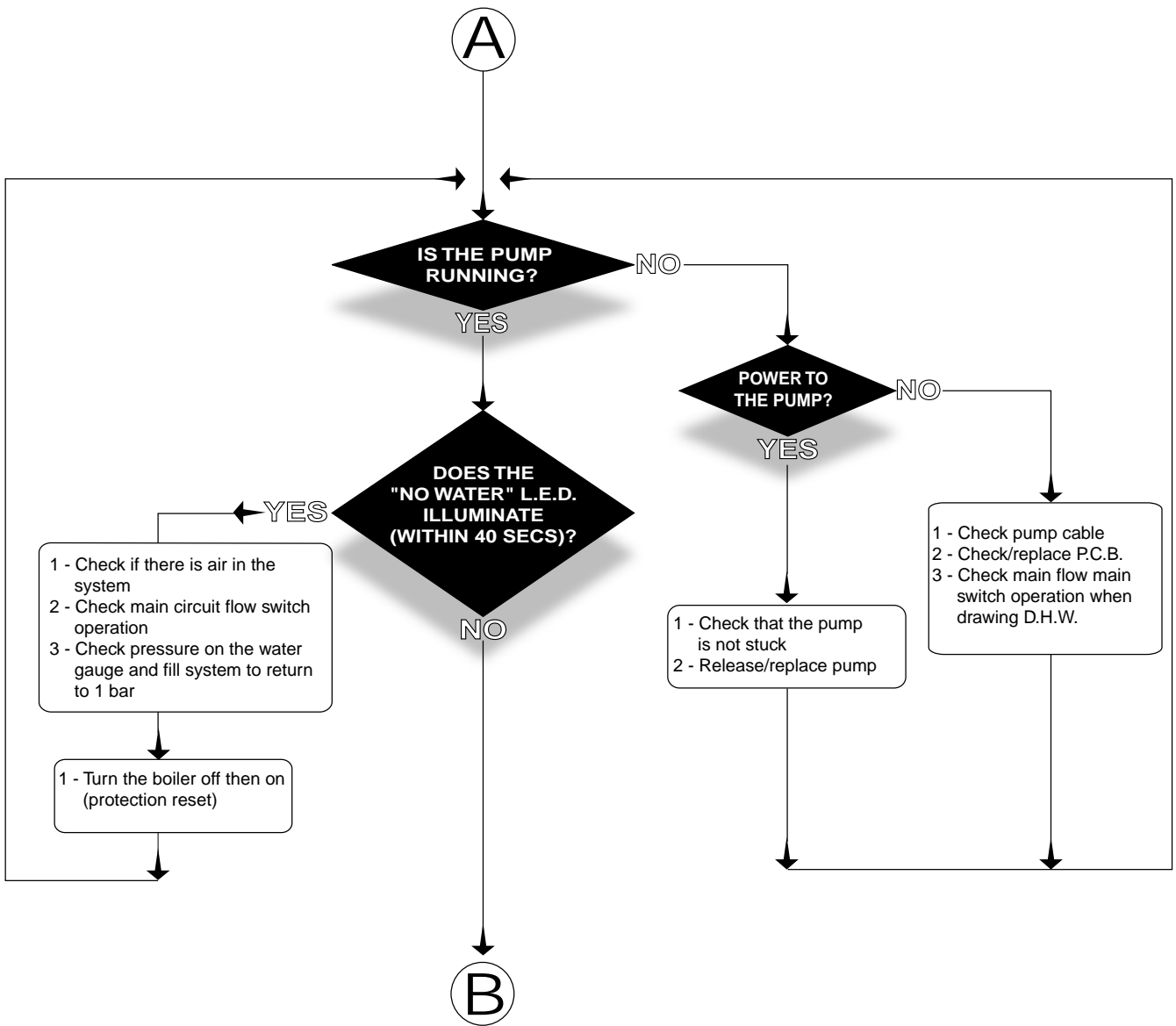

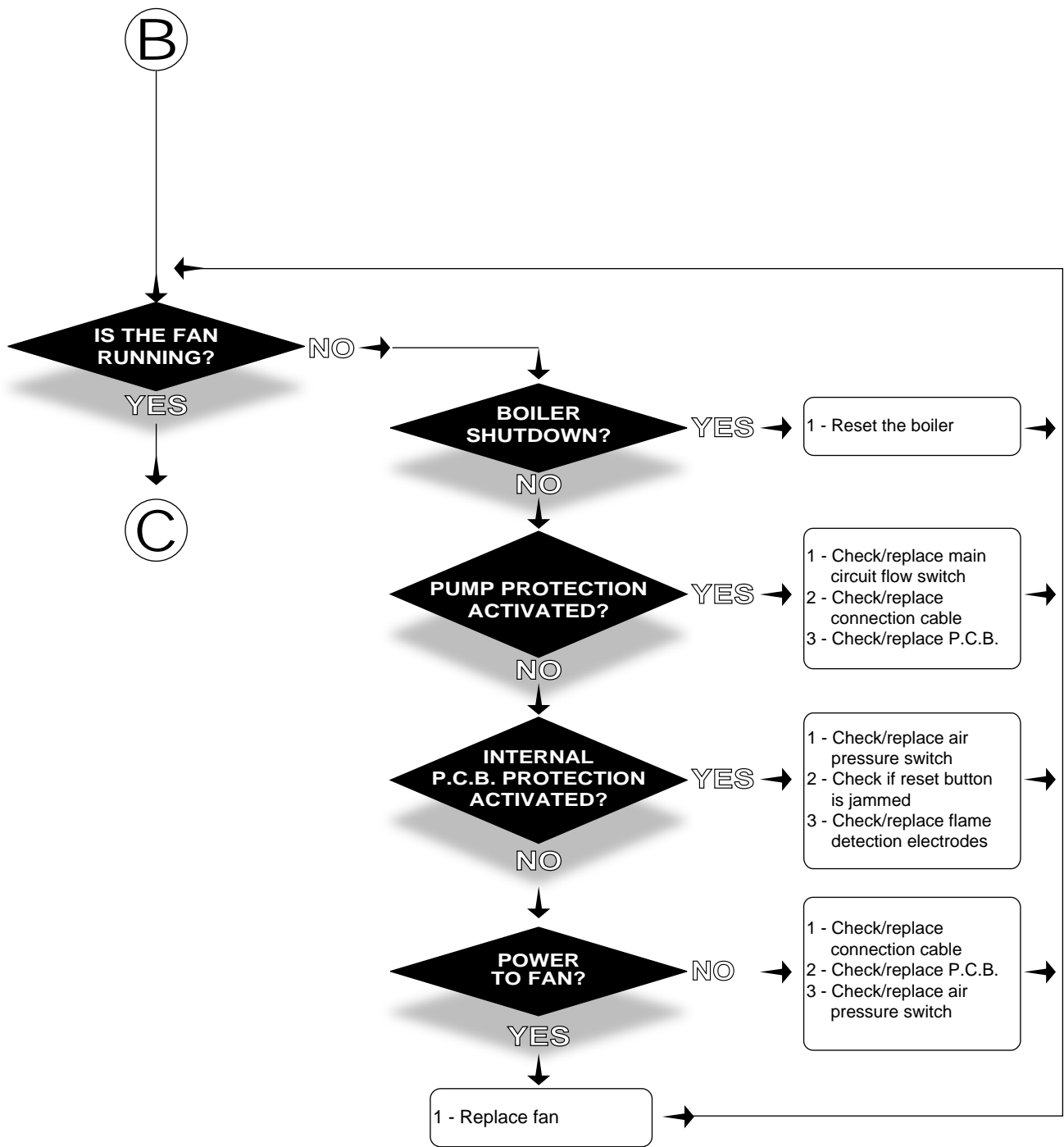

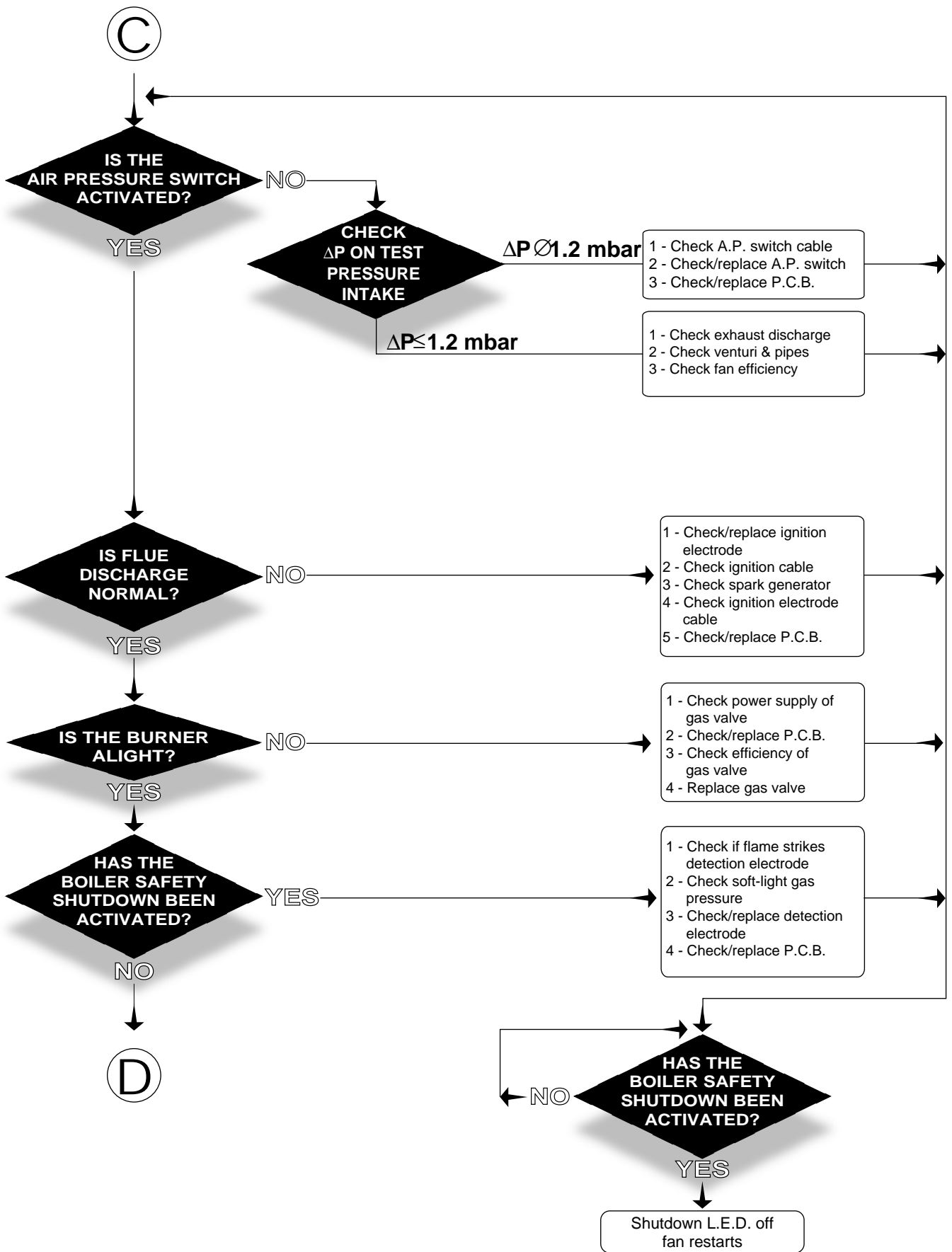

D

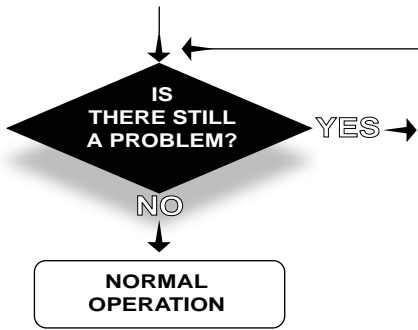

	<i>FAULTS</i>	<i>POSSIBLE CAUSES</i>
1	Drawing D.H.W: When you turn on a tap burner switches off	- air in secondary heat exchanger - faulty main circuit flow switch - faulty D.H.W. flow switch
2	Drawing D.H.W: radiators heat up in summer mode	- faulty 3-way valve
3	Drawing D.H.W: insufficient hot water temperature	- check C.H./D.H.W. temperature probes - check gas pressures - check water flow rate - check secondary heat exchanger
4	Drawing D.H.W: noisy operation	- primary heat exchanger faulty or lime-scale deposits - low heating system water pressure - check gas pressures - check C.H./D.H.W. temperature probes
5	Decrease/increase heating circuit pressure	- check for leaks on the heating circuit - faulty filling-loop - faulty secondary heat exchanger - expansion vessel faulty
6	Repeated shutdowns	- faulty detection electrodes - check gas settings - check flame detection electric circuit
7	Repeated intervention of safety thermostat	- C.H./D.H.W. temperature probes open circuit - overheat thermostat not calibrated correctly - air in primary water circuit
8	When cold water tap turned off, the boiler ignites	- drop in pressure in the water mains, with consequent water hammer
9	Insufficient radiator temperature	- check C.H. temperature probe - check by-pass - check gas pressures



3. **ELECTRICAL DIAGRAMS**

LEGEND:

A	=	Time Clock Connector
B	=	Central Heating Selection (Winter) and Temperature Adjustment
C	=	Connector for Total Check System
D	=	Domestic Hot Water Temperature Adjustment
E	=	Soft-light Adjustment
F	=	Maximum Heating Adjustment
G	=	On/Off Switch
H	=	On/Off L.E.D.
I	=	Fume Sensor L.E.D.
J	=	Ignition Failure (Lockout) L.E.D.
K	=	Low System Water Level/Lack of Circulation L.E.D.
L	=	Reset Button
M	=	Economy/Comfort Selector
N	=	Overheat L.E.D.
O	=	Temperature L.E.D.s
P	=	Transformer
Q	=	Circulation Pump Relay
R	=	Fan Relay
S	=	Gas Valve Relay
T	=	Motorised Diverter Valve Relay
V	=	Spark Generator
U	=	Anti-cycling Device Adjustment for Heating

A01	=	Circulation Pump
A02	=	Fan
A03	=	Spark Generator/Gas Valve Supply
A04	=	Motorised Diverter Valve
A05	=	Flame Detection Circuit
A06	=	Detection Electrode
A07	=	Main Circuit Temperature Probe
A08	=	Domestic Hot Water Temperature Probe
A09	=	Domestic Hot Water Flow Switch
A10	=	Main Circuit Flow Switch
A11	=	Modulator
A12	=	Air Pressure Switch
A13	=	Safety Thermostat
A14	=	External (Room) Thermostat

Colours:

Gry	=	Grey
Wh	=	White
Pnk	=	Pink
Brn	=	Brown
Bl	=	Blue
Blk	=	Black
Rd/Blk	=	Red/Black

microGENUS 23/27 MFFI

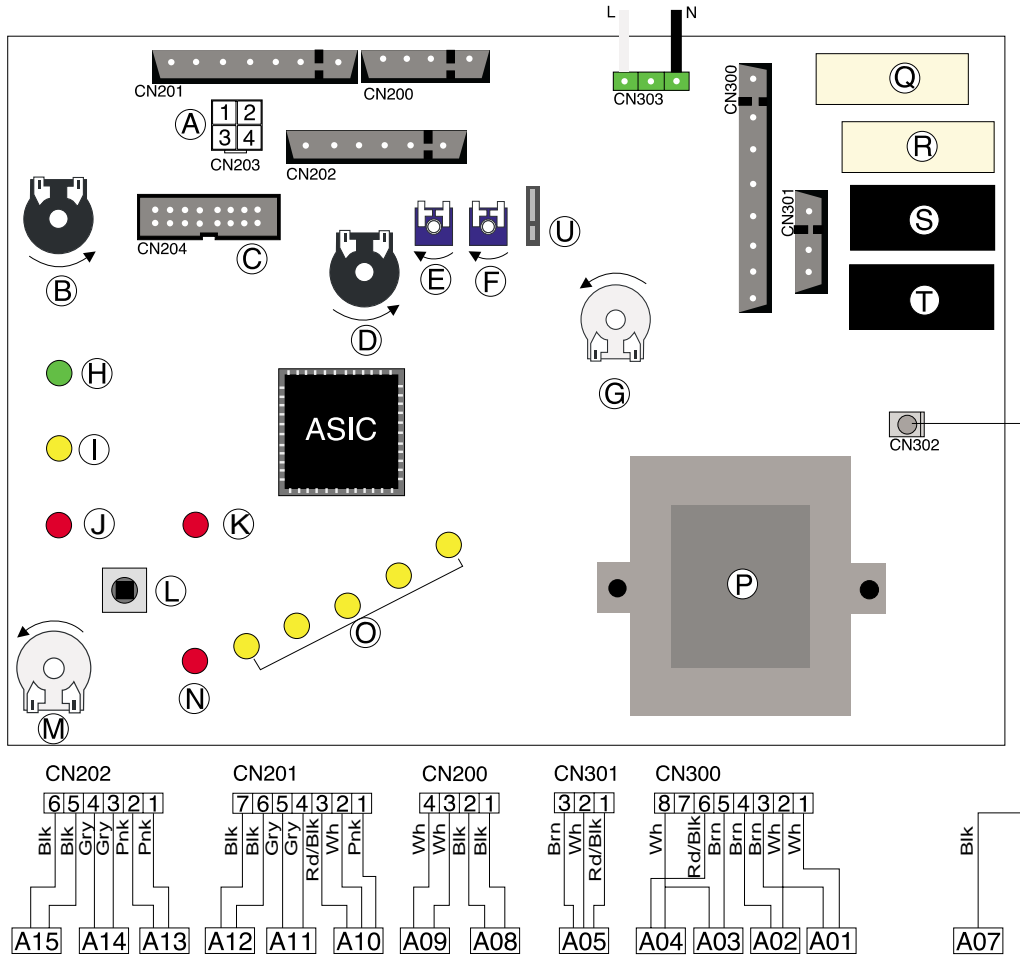

SE017A

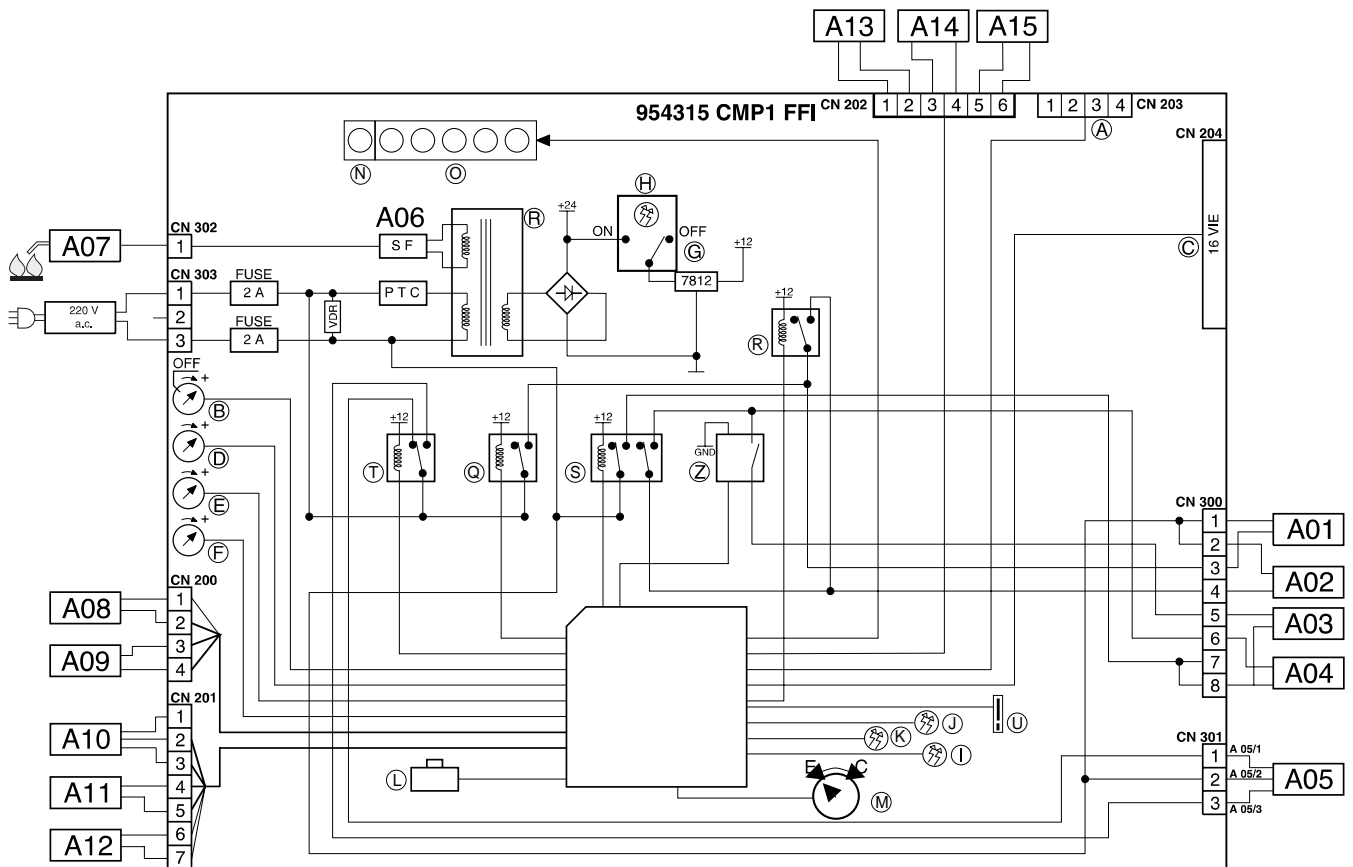

SF014A

4. SHORT SPARE PARTS LIST

microGENUS 23/27 MFFI

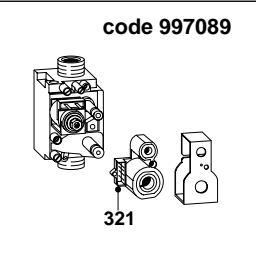
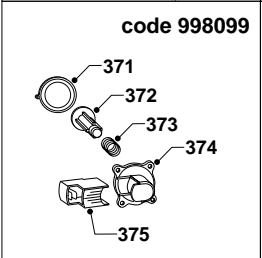
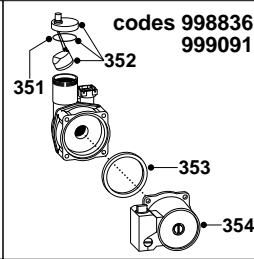
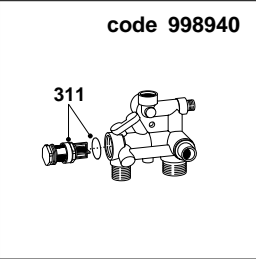
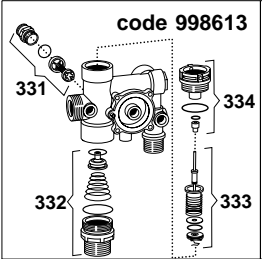
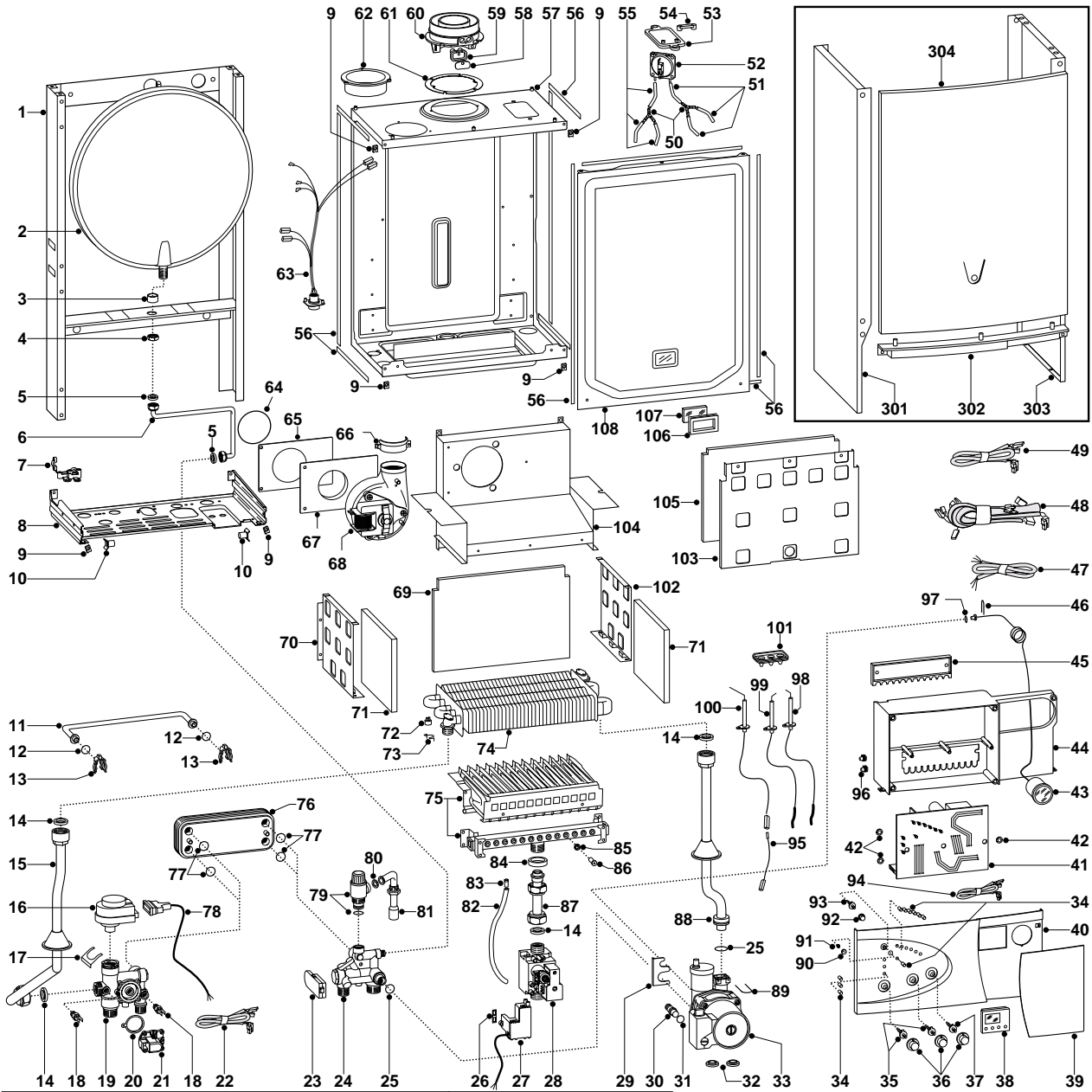

MODELS	CHARACTERISTICS	SERIAL NO: VALIDITY	REF.
MICROGENUS 23 MFFI	METHANE	2320005600001	A
MICROGENUS 23 MFFI	LPG	2320005600001	B
MICROGENUS 27 MFFI	METHANE	2320005600001	C
MICROGENUS 27 MFFI	LPG	2320005600001	D

Manufacturer: **Merloni TermoSanitari SpA - Italy**

Commercial subsidiary: **MTS (GB) LIMITED**

MTS Building

Hughenden Avenue

High Wycombe

Bucks HP13 5FT

Telephone: (01494) 755600

Fax: (01494) 459775

internet: <http://www.mtsgb.ltd.uk>

E-mail: info@mtsgb.ltd.uk

Technical Service Hot Line: (01494) 539579