

User's Instructions

Alpha 240X

**Wall Mounted, Fan Assisted, Room Sealed, Gas Fired
Combination Boiler**

For Technical help or for Service call ...

ALPHA HELPLINE

Tel: (01322) 669443

Alpha
BOILERS

Goldsel Road,
Swanley, Kent BR8 8EX
Fax: (01322) 615017

British Gas
Service Listed



Alpha 240X

G.C. No. 47 532 13



For use with Natural Gas only

Leave these instructions with the User

1 DESCRIPTION

The Alpha 240X boiler is a wall mounted, fan assisted room-sealed combination boilers, providing both central heating and domestic hot water at mains pressure and it uses a permanent pilot for lighting the burner.

The Alpha 240X boiler is suitable for central heating loads of between 9.3 and 23.3 kW (31 700 and 79 500 Btu/h).

The boiler will provide central heating (as required) during the 'on' times set on your clock (if fitted). Hot water is always available whenever a hot tap is opened and takes priority over the central heating.

2 USER CONTROLS

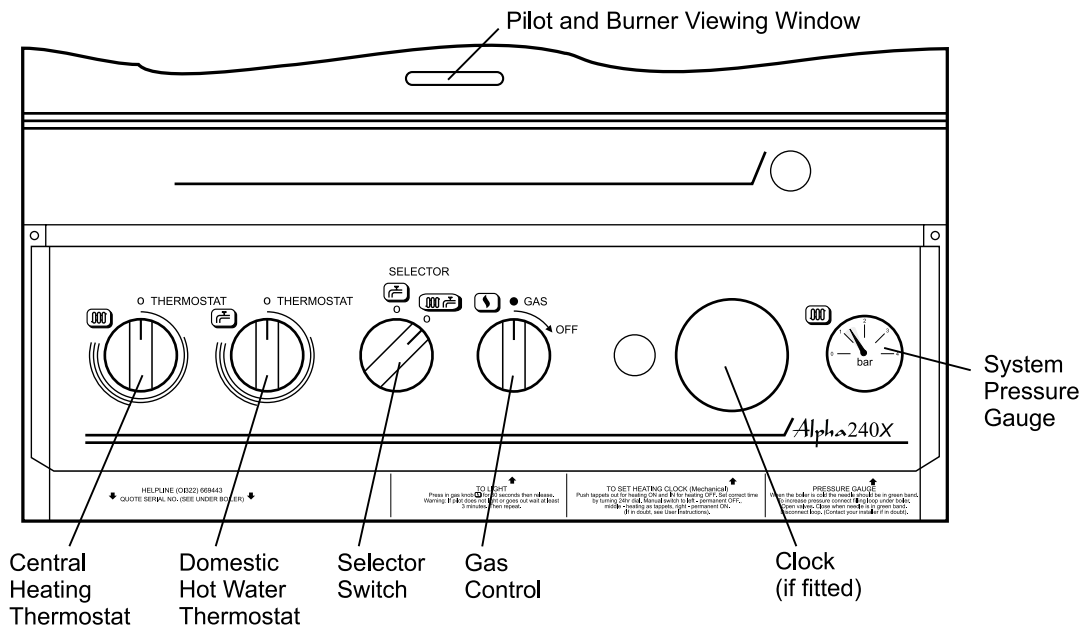

Fig. 1

3 BOILER CONTROLS

1. CENTRAL HEATING THERMOSTAT

This thermostat controls the temperature of the water leaving the boiler for the heating system. For maximum output from the radiators the thermostat should be left at maximum i.e. fully clockwise. If lower heating temperatures are required, turn the thermostat anti-clockwise.

2. DOMESTIC HOT WATER THERMOSTAT

This thermostat controls the temperature of the domestic hot water leaving the boiler. For maximum hot water temperatures the thermostat should be left at maximum i.e. fully clockwise. If lower temperatures are required, turn the thermostat anti-clockwise.

3. SELECTOR SWITCH

This control allows the boiler to provide central heating and hot water **or** hot water **only**.

4. PRESSURE GAUGE

This indicates the central heating system pressure. It should always be within the green band when cold, increasing slightly when hot. If the pressure falls below the green band i.e. lower red area, refer to the label on the pull out panel for guidance on re-pressurising the system. Or contact your Installer to have the system checked and pressurised.

5. OVERHEAT THERMOSTAT



This thermostat automatically switches the boiler off in the unlikely event of the boiler overheating. When the thermostat operates it turns the pilot off, and the pilot will have to be relit. Refer to the lighting instruction in section 4. If this continually happens, contact your Service Engineer.

6. PRESSURE RELIEF VALVE

If the central heating system overheats and steam or water is discharged from the pipe connected to this valve, turn the boiler off and contact your Service Engineer. Your Installer should have told you where this pipe terminates somewhere outside your dwelling.

4 LIGHTING INSTRUCTIONS

Refer to Fig. 1 for boiler controls.

1. Ensure the following:-
 - a. Electrical supply to the boiler is off.
 - b. All heating controls and thermostats are set to OFF or minimum position.
 - c. All isolation valves at the bottom of the boiler are in the open position (flats on the spindle in line with the valves i.e. ).
 - d. The gas and water supplies are on at the mains.
 - e. The heating system pressure is within the green band as shown by the pressure gauge.
2. Turn the heating and hot water thermostats fully anticlockwise to 0.
3. Switch on the electrical supply to the boiler.
4. Set any room thermostats to maximum and ensure that any clock is in an 'on' position. Refer to section 8, if a clock is fitted in the boiler control panel.
5. Set the selector switch to  (hot water only).

Fully depress the gas control and keep it pressed in. After a delay of about 20 seconds the ignition sparks will start and the pilot will light. When the pilot lights (view through the window in the boiler case) keep the gas control pressed in for a further 20 seconds then release. The pilot should remain alight.
If the pilot does not remain alight, release the gas control and turn it off in the direction of the arrow i.e. clockwise.

Warning: If the pilot is extinguished at this or any other time, wait at least 3 minutes before attempting to relight the boiler.
6. Turn the hot water thermostat fully clockwise. Open a hot water tap, the main burner will light and the boiler will provide hot water. Close the tap and the burner will go out.
7. Set the selector switch to  (central heating and hot water) and turn the heating thermostat fully clockwise. The main burner will light and the boiler will provide central heating.
8. Set the boiler thermostats, clock, external controls i.e. room thermostat to your chosen settings and the boiler is ready to operate.

To turn the central heating off i.e. in Summer:- Set the selector switch to  (hot water only).

To turn the boiler off for short periods:- Set the selector switch to  (hot water only) and leave the pilot alight. Ensure all domestic hot water taps are turned off.

To turn the boiler off for longer periods:- Switch off the electrical supply to the boiler and turn off the pilot by turning the gas control clockwise. If required, all supplies i.e. gas, water and electricity may be turned off at the mains. If there is any possibility of the boiler being left during frost conditions, then the boiler and system should be drained and a label attached to the boiler drawing attention that the system has been drained. If this is required, contact your Service Engineer.

5 BOILER OPERATION

The operating sequence of the boiler is controlled by the selector switch on the control panel. With the switch set to  (hot water only) the boiler will only operate to provide domestic hot water, ideal for Summer use when central heating is not required.

Setting the selector switch to  (central heating and hot water) the boiler will operate to provide both central heating and hot water.

If the boiler is operating to provide central heating and a hot water tap is opened, the boiler will automatically switch over to provide hot water. Such an interruption in the central heating should not generally be noticed by any reduction in room temperature.

Note: If a clock is fitted to the boiler, it will only control the operating times of the central heating. Hot water will always be available when a tap is opened.

When the selector is set to central heating and hot water, it will respond to a demand for heat in the following sequence:-

- a. The pump will start, the fan will operate at full speed and the main burner will light.
- b. The output of the burner is automatically controlled to suit the system demand.
- c. When the temperature of the system water in the boiler reaches that set by the thermostat or the room thermostat is satisfied, the main burner is turned off and the fan returns to low speed.
- d. When a hot tap is opened, the boiler automatically senses a flow of water. The pump will start, the fan will operate at full speed and the main burner will light.
- e. The boiler will continue to supply hot water at the temperature set by the thermostat until the tap is closed.

Note: When there is no demand for either central heating or domestic hot water, the fan runs at low speed and the pilot remains permanently alight.

6 HOT WATER USE

The supply of hot water is almost instantaneous at the boiler, but the time taken to reach a tap and the temperature at which it leaves the tap will depend on the rate at which the water is drawn off and the length of the pipe between the tap and the boiler.

Fully opening a hot tap may not always provide the maximum temperature as the flow rate may be too high, try closing it slightly until the maximum temperature is achieved.

Depending on your mains water pressure, it may not be possible to operate several hot taps at the same time.

7 USING A SHOWER

Thermostatic or pressure equalising type - When using these types of shower set the boiler domestic hot water thermostat to maximum. The shower should then maintain a relatively constant temperature.

Manual bath mixer type shower - When using this type of shower set the boiler domestic hot water thermostat to the 7 o'clock position. This should avoid excessive temperatures at the shower.

Note: If you get unacceptable temperature variations with this type of shower, then a thermostatic or pressure equalising type should be used.

8 IMPORTANT NOTES

1. BOILER LOCATION

Always ensure the following clearances are available around the boiler:-

Top: 220 mm, Bottom: 250 mm, Each side: 5 mm, Front: 450 mm

Do not store any other articles in the cupboard containing the boiler and never place any clothing or combustible material on or near the boiler or flue pipe.

2. FLUE TERMINAL

The terminal on the outside wall must not be allowed to be obstructed. If it is damaged, in any way, turn the boiler off and contact your Service Engineer. In cold weather, vapour may be emitted from the terminal. This is quite normal.

3. MAINS FAILURE

In the event of an electrical supply failure the boiler will not operate. When the supply is restored, the boiler will return to normal operation. However, check that the pilot is alight by viewing through the window and if not, refer to the lighting instructions in section 4. Remember to reset the clock when the supply is restored.

If the mains water supply fails, there will be no hot water from the taps. The boiler will continue to provide central heating.

4. ADDITIONAL BATHROOM FITTINGS

Any equipment such as mixing valves, showers, bidets etc. must be designed to operate at mains water pressure. Contact your plumbing merchant or installer for advice when considering purchasing such items.

5. CLEANING

Use only a damp cloth and mild detergent to clean the boiler outer casing. Do not use abrasive cleaners.

6. SERVICING

To maintain efficient and safe operation of your boiler, routine annual servicing is essential.

For advice on servicing contact:- The Alpha Helpline: 01322 669443.

7. GAS LEAK

If a fault or gas leak is suspected, turn off the gas supply. Do not touch any electrical switches, do not smoke and extinguish all naked flames. Contact your local Gas Region immediately.

8. ELECTRICAL SUPPLY

The boiler requires a 230/240 V ~ 50 Hz supply, fused at 3 A if a 13 A 3-pin plug is used or a 5 A fuse if any other type of plug is used.

To connect a plug:-

The colour of the wires in the mains lead of the boiler may not correspond with the coloured markings identifying the terminals in your plug. In this case proceed as follows:-

The wire coloured green and yellow must be connected to the terminal in the plug that is marked with the letter **E**, or by the earth symbol , or coloured green or green and yellow.

The blue wire must be connected to the terminal which is marked with either the letter **N** or coloured black.

The brown wire must be connected to the terminal which is marked with the letter **L** or coloured red.

THE APPLIANCE MUST BE EARTHED.

9 GAS SAFETY REGULATIONS

Gas Safety (Installation and Use) Regulations:-

It is the law that all gas appliances are installed and serviced by a competent person, ie CORGI registered personnel. Failure to install or service appliances correctly could lead to prosecution. It is in your interest and that of safety to ensure compliance with the law. The manufacturer's instructions must not be taken in any way as over-riding statutory obligations.

The Benchmark Log Book must be fully completed by the installer on installation of the boiler. All CORGI registered installers carry a CORGI ID card and have a registration number. Both should be recorded in your central heating Log Book. You can check your installer is CORGI registered by calling CORGI on 01256 372300.

10 CLOCK (if fitted)

The clock allows you to set the times at which the boiler will operate to provide central heating. It does not affect the supply of domestic hot water, which is always available whatever the setting of the clock.

1. TO SET THE TIME

Turn the outer dial clockwise to set the clock hands to the correct time.

(Ensure the time indicator corresponds with the correct time on the 24hr dial as shown in Fig. 2, e.g. 3.00pm = 15 not 3).

NOTE: Do not rotate the dial anti-clockwise

2. TO SET THE ON/OFF PERIODS

Select the ON times by pushing the tappets out.

Select the OFF times by pushing the tappets in.

Fig. 2 shows the clock set as follows:-

ON	3.00pm	to	10.00pm (15 - 22)
OFF	10.00pm	to	5.00am (22 - 5)
ON	5.00am	to	8.00am (5 - 8)
OFF	8.00am	to	3.00pm (8 - 15)

3. MANUAL SWITCH

The clock has a manual On/Off switch which operates as follows:-

Mid position	Heating On/Off as set by the tappets
Position I (right)	Heating On continuously
Position 0 (left)	Heating Off continuously

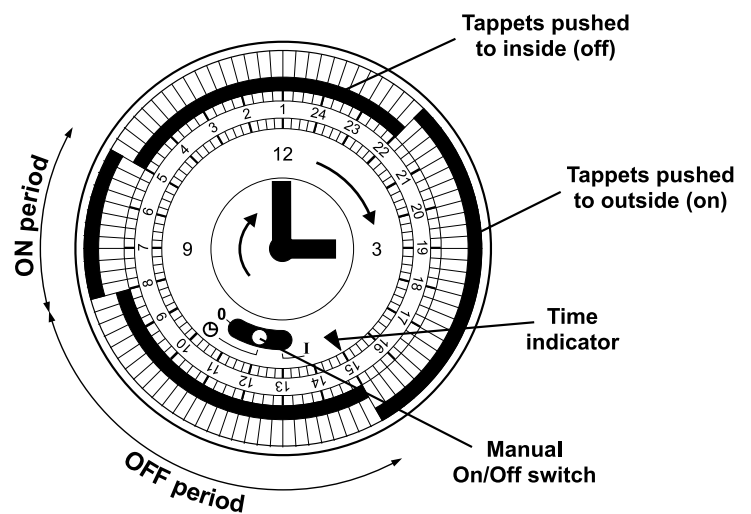
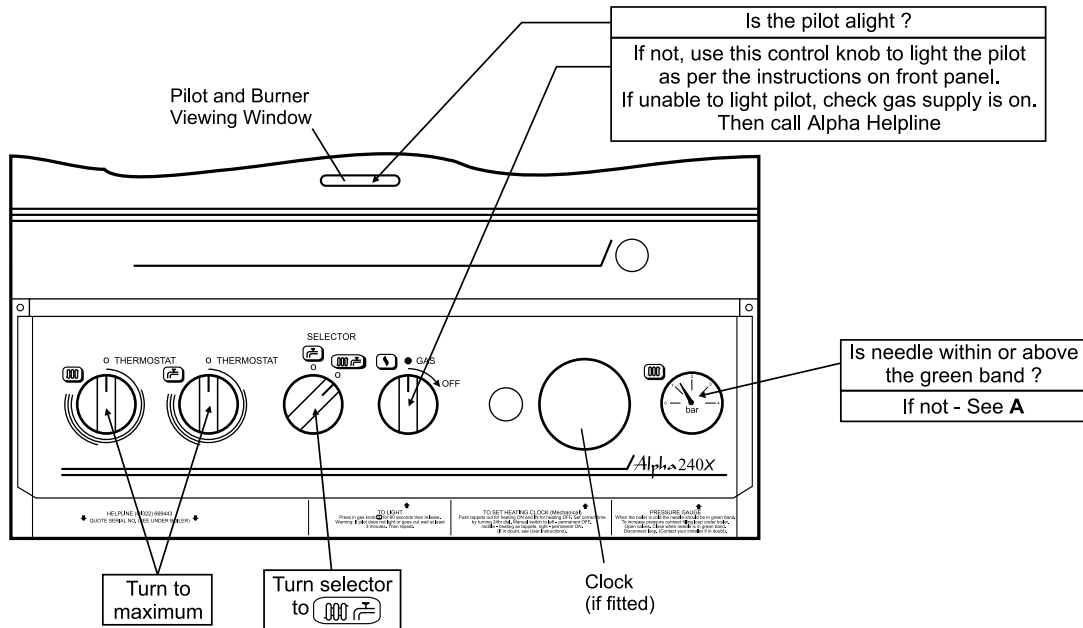

Fig. 2

11 FAULT FINDING FOR THE USER

If you experience a problem of no heating or hot water, try to solve the problem by following the simple checks below before calling out a service engineer.



A - Refer to the label on the front panel for guidance on re-pressurising the system. Or contact your installer. Or

Also check:-

1. The electrical supply to the boiler is on. If so
2. All controls are calling for heat i.e. room thermostat, clock. If so

**Ring the
Alpha Helpline Service
Tel: 01322 669443**

You will be asked
the Serial No. of your
boiler when you ring.

The Serial No. of the
boiler is on the front
panel.

Alpha BOILERS

Alpha Therm Limited.
Goldsel Road, Swanley, Kent BR8 8EX
Tel: (01322) 669443
Fax: (01322) 615017

These instructions have been carefully prepared but we reserve the right to alter the specification at any time in the interest of product improvement.

© Alpha Therm Limited 1999.

Part No. 920.682.1