

HeatMaster®

35^{TC}

Installation, Operating and Servicing Instructions



INDEX

WARNINGS	3
Who should read these instructions	3
Symbols	3
Recommendations	3
Applicable standards	3
Warnings	3
INTRODUCTION	4
Description of the specifications	6
Production of hot water	6
Frost protection	6
USERS GUIDE	7
Direction for use	7
Settings parameters	7
TECHNICAL CHARACTERISTICS	8
Natural gas categories	9
Propane categories	9
Domestic hot water features	9
ELECTRICAL CONNECTION	10
Wiring diagram : HeatMaster® 35 TC	10
INSTALLATION INSTRUCTIONS	11
Dimensions	11
Boiler room	11
INSTALLATION	12
Connection to the chimney	12
Connection to the gas	13
Domestic hot water connection	13
Heating connections	14
Installation of a single high temperature circuit with room thermostat ACV 15 control	15
Installation of a weather depending heating circuit high or low temperature	16
Installation of two heating circuit controlled by control unit and ZMC-1 module	18
COMMISSIONING AND MAINTENANCE	20
Commissioning the system	20
Inspection and maintenance	20
Disassembling the burner	21
Disassembling and checking the electrode	21
Cleaning the heat exchanger	21
Temperature sensor resistance tables	21
MCBA PARAMETERS FOR THE SPECIALIST	22
Standby mode	22
Setting the MCBA parameters	23
Request for information on the installation	24
Entering the code	24
MCBA parameters with code restricted access	25
Communication mode	28
Error mode	28
Safety stop [error mode]	29
SPARE PARTS	see at the end of this manual

WARNINGS

WHO SHOULD READ THESE INSTRUCTIONS

These instructions should be read by:

- the specifying engineer
- the installer
- the user
- the service engineer

SYMBOLS

The following symbols are used in this manual:



Essential instruction for the correct operation of the installation.



Essential instruction for the safety of persons and the environment.



Danger of electrocution.



Danger of burns

RECOMMENDATIONS



- Please, read carefully this manual before installing and commissioning the boiler.
- It is prohibited to carry out any modifications to the inside of the appliance without the manufacturer's prior and written agreement.
- The product must be installed and serviced by trained engineers, in compliance with current standards.
- Any failure to follow instructions relating to tests and test procedures may result in personal injury or risks of pollution.
- To guarantee safe and correct operation of the appliance, it is important to have it serviced and maintained every year by an approved installer or maintenance company.
- In case of anomaly, please call your service engineer.
- Despite the strict quality standards imposed by ACV during the manufacture, inspection and transport of its appliances, you might notice some errors. Please report immediately any fault to your approved installer. Remember to note the fault code displayed on the screen.

- The parts may only be replaced by genuine factory parts. You will find a list of the spare parts and their reference number ACV to the end of this document.
- The burners are preset in our factory for use with natural gas [equivalent to G20].
- An ajustement of the CO2 is not allowed in Belgium I 2E(s)B.



- It is important to switch the boiler off before carrying out any work.
- There are no user accessible parts inside the boiler casing.

APPLICABLE STANDARDS

The appliances carry the CE mark in accordance with the standards in force in the various countries (European Directives 92/42/EC "Efficiency", 90/396/EC "Gas appliances"). They also carry the "HR-TOP" label (Gas condensation boilers).



WARNINGS

IF YOU SMELL GAS:

- Immediately shut off the gas intake.
- Open windows for fresh air flowing.
- Do not use any electrical appliances and do not actuate any switches.
- Immediately notify your gas supplier and/or your installer.

This documentation is part of the information delivered with the appliance and must be given to the user and stored in a safe place!

An approved installer must carry out the assembly, commissioning, maintenance and repair of the system, in accordance with current standards in force.

ACV shall not accept any responsibility for damage caused by noncompliantlocation of the system or by use of the parts or connections not approved by ACV for this application.



The manufacturer reserves the right to change the technical characteristics and specification of its products without notice.



The availability of some versions and their accessories is market dependant.

INTRODUCTION

The HeatMaster® 35 TC combines the unique ACV Tank-in-Tank concept with a dual primary circuit resulting in exceptional performance from a totally condensing combination boiler.

Tank-in-Tank technology

ACV's advanced implementation of thermal storage technology is tried and tested and is remarkably simple, efficient and reliable. At the heart of the HeatMaster® TC is a stainless steel tank through which the flue tubes pass.

This is surrounded by a mild steel shell containing the primary water, which extends down to the combustion chamber and even around the flue tubes. The burner fires onto the primary water which indirectly heats the stainless steel tank containing the hot water. As with all Tank-in-Tanks, this is corrugated over its full height and is suspended in the HeatMaster® TC by its hot and cold water connections.

The area of the heat transfer surface is therefore much greater than that of standard direct fired water heaters. A much larger heat transfer surface means that Tank-in-Tank units recover much faster than any other kind of hot water storage device - and keeps boiler cycling to a minimum. The high storage temperature within the inner tank also results in exceptional hot water outputs.

Dual primary circuit technology

The HeatMaster® TC primary circuit is split into two sections - a high temperature upper circuit and a low temperature lower circuit, divided by a separation plate. The hot water storage tank is located in the upper circuit which always operates at a temperature of between 60°C and 90°C. This is ideal for hot water production as it maintains the stored water at constantly high temperatures, eliminating bacterial formation such as Legionellae, as well as resulting in high volume hot water production.

The down-firing flue tubes pass through the upper circuit, through the separation plate and into the lower circuit. The primary water here operates at a temperature typically between 30°C and 60°C for heating (dependent on the heating return temperature), perfect for condensing when working in heating mode.

Dual coil technology

During hot water mode, the bottom circuit operates at a much lower temperature, typically 5°C to 20°C depending on the cold water inlet temperature. The incoming cold water enters the lower primary circuit via a dual stainless steel coil which preheats the domestic water prior to it passing into the stainless steel tank located in the upper circuit. As the coil is wrapped around the lower flue tubes of the combustion chamber, it is able to absorb the remaining heat from the flue gases. The result is that during hot water mode the HeatMaster® TC totally condenses whether on full or part-load.

Operating modes

In both heating and hot water modes, the premix gas burner fully modulates the power to match the system demand.



1

Heating

The heating return enters the lower circuit of the boiler, which allows the boiler to operate in condensing mode. The upper circuit of the HeatMaster® TC is kept at a consistently high temperature due to the internal shunt pump which ensures that the primary water circulates around the heat exchanger flue tubes.



2

Hot water

With the upper circuit maintained at high temperature, the HeatMaster® TC is always ready to supply hot water on demand. The cold water enters through the dual coil at the base of the heat exchanger and is pre-heated before entering the hot water tank. The low temperature of the bottom circuit results in continuous condensation of the flue gases in hot water mode.



3

Heating and hot water

Once up to temperature, the HeatMaster® TC is capable of producing heating and hot water simultaneously.

INTRODUCTION

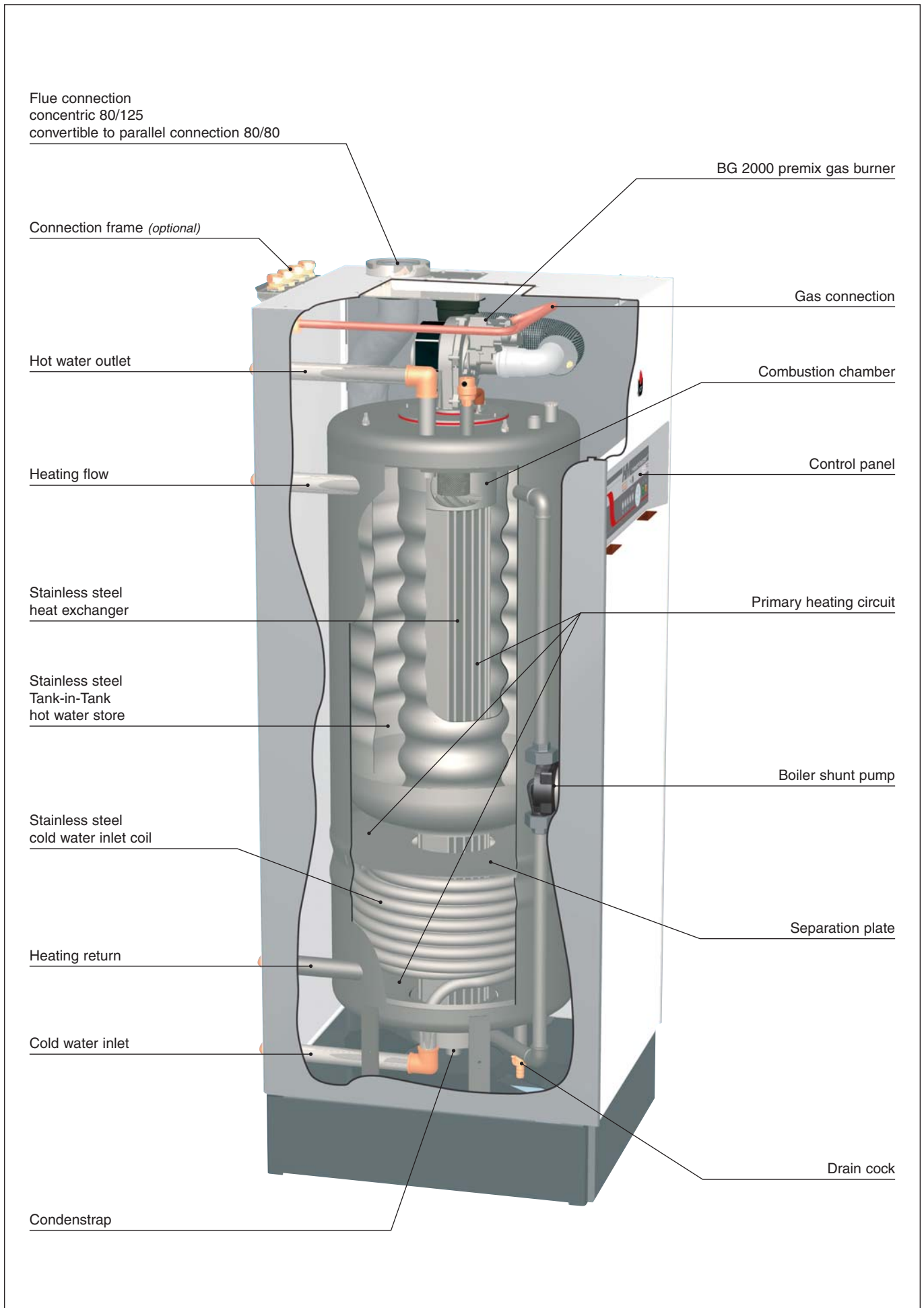

INTRODUCTION

DESCRIPTION OF THE SPECIFICATIONS

The **HeatMaster® TC** is an hot water producer combined in a condensing boiler in accordance to the Belgium "HR-Top" standard. The boiler is certified compliant with "CE" standards as a connected appliance C13(x), C33(x), C43(x), C53, C83(x), but it can also be connected as an open appliance in category B23.

Lining

The boiler is protected by a steel lining that first of all undergoes a degreasing and phosphation process before being lacquered and heated at 220°C. The inside of this lining is coated with a layer of thermal and acoustic insulation, reducing losses to a minimum.

Heat exchanger

The core of the **HeatMaster® TC** features a new stainless steel heat exchanger. This piece of technology represents the fruit of exhaustive research and intensive laboratory testing. It reflects ACV's eighty years of experience in using stainless steel for heating and hot water functions. The particular geometry of the exchanger pipes is calculated to obtain a very large Reynolds number throughout its cycles.

The **HeatMaster® TC** achieves an exceptional output that remains stable throughout the boiler's life, given that it causes no oxidation on the exchanger, which is manufactured entirely from quality steel.

Burner

ACV uses its BG 2000-M burner for the **HeatMaster® TC**: this is an air/gas premix burner providing safe and silent operation while limiting emissions (NOx and CO) to an incredibly low level. Although the ACV BG 2000-M boiler is very modern, it uses proven technology and is manufactured from standard spare parts that are easily available on the market.

Temperature regulation

The basic version of the **HeatMaster® TC** is fitted with a microprocessor controlled regulator (MCBA) which takes over both the safety functions (ignition, monitoring the flame, limiting the temperature, etc.) and control of the boiler temperature.

This MCBA also includes a weather-dependent regulator. All you need to do is connect the outdoor temperature sensor available as an option to the device. However, this regulator can also operate with a standard on/off room thermostat. In addition, with the combination of a weather-dependent regulator and a room thermostat, you can control the temperatures based on the weather with compensation for the indoor temperature.

There are four user adjustable parameters. By entering a special maintenance code, qualified installers can access several other parameters to adapt the boiler to special requirements. In principle, these parameters are factory set for all normal applications.

PRODUCTION OF HOT WATER

In addition to its exceptional hot water performances, the **ACV** Tank-in-Tank concept provides the following advantages :

- **A solution for scale deposits:** thanks to the specially designed corrugations, the hot water tank expands and contracts during the heating cycle, preventing the formation of scale.

- **A guarantee against the risk of Legionellae Disease and bacteria:** the hot water tank is fully immersed in the primary circuit and the hot water is constantly kept at a temperature above 60°C.

- **Exceptional resistance against corrosion and aggression:** provided by the stainless steel.

FROST PROTECTION

The boiler is equipped with an integrated frost protection: as soon as the boiler temperature drops below 7°C, the system activates the central heating pump. As soon as the NTC1 flow temperature drops below 3°C, the system automatically ignites the burner until the temperature rises above 10°C. The pump continues to run for about 10 minutes.

If an outdoor temperature sensor is connected to the system, the pump is activated as soon as the outside temperature drops below the specified threshold.

To provide efficient protection for the whole system, all valves of the valves on the radiators and the convectors should be completely open.

DIRECTIONS FOR USE

Your system must be checked once a year by an approved installer or maintenance company.

Starting the burner

During operation, the burner starts automatically as soon as the boiler temperature drops under the required set point and it stops as soon as the boiler reaches that temperature.

Control panel

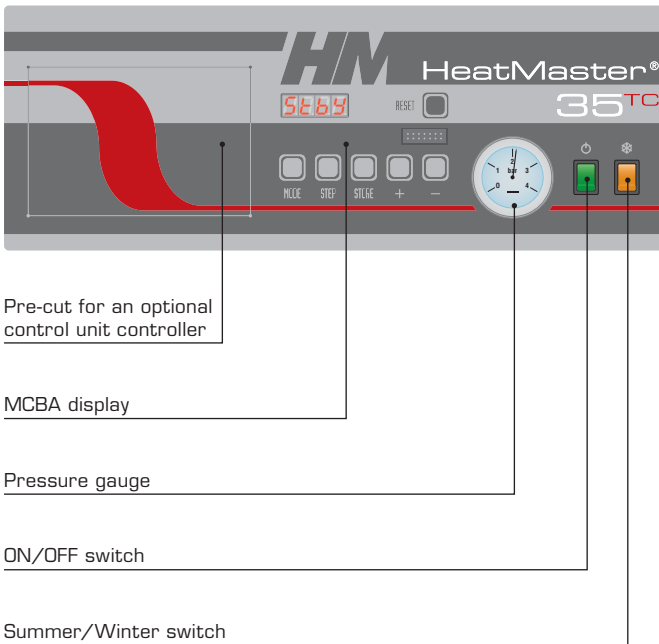

Heating system

The central heating circuit must be pressurized (see in the chapter "Installation" how to define the system pressure). The pressure indicator is located on the right-hand side of the display.



If your system needs to be refilled more than twice a year, please contact your installer.

The CH pressure must be a minimum of 1 bar and must be checked by the end user on a regular basis. If the pressure drops under 0.5 bar, the integrated water pressure switch blocks the appliance until the pressure in the system returns to a level above 0.8 bar. The connection for a fill valve is provided underneath the appliance. The installer can also fit the system with a separate valve. Make sure that the appliance is powered off when filling the system. To do this, toggle the Start/Stop switch located on the left of the screen to Off. (see the Control panel).

For more information, please ask your installer when the system is delivered.

A safety valve is provided at the underneath of the appliance. If the system pressure exceeds 3 bars, this valve opens and drains the water from the system. In this case, please contact your installer.

SETTINGS PARAMETERS

Setting the domestic hot water temperature:

(Hot water temperature)

- Press **Mode**: The screen displays **PARA**.
- Press **Step**: the first character is **1** and the last two characters give the current hot water temperature setting.
- To change this temperature, press + or - until the last two digits show the desired temperature value.
- Press **Store** to save the new temperature setting.
- Press **Mode** twice to return to Pilot mode (normal operating mode).

Enabling or disabling the hot water heating mode:

(hot water)

- Press **Mode**: The screen displays **PARA**.
- Press **Step** twice: the first character is **2** and the last two characters give the current setting:
00 = disabled; **01** = enabled.
- To change this parameter, press + or - until the screen displays the desired value:
00 = disabled; **01** = enabled.
- Press **Store** to save.
- Press **Mode** twice to return to Pilot mode (normal operating mode).

Enabling or disabling Central Heating mode:

(heating)

- Press **Mode**: The screen displays **PARA**.
- Press **Step** three times: the first character is **3** and the last two characters give the current setting:
00 = disabled; **01** = enabled.
- To change this parameter, press + or - until the screen displays the desired value:
00 = disabled; **01** = enabled.
- Press **Store** to save.
- Press **Mode** twice to return to Pilot mode (normal operating mode).

Setting the central heating temperature:

(maximum temperature for the heating circuit)

- Press **Mode**: The screen displays **PARA**.
- Press **Step** four times: the first character is **4** and the last two characters give the current central heating temperature setting.
- To change this temperature, press + or - until the last two digits show the desired temperature value.
- Press **Store** to save the new temperature setting.
- Press **Mode** twice to return to Pilot mode (normal operating mode).

Fault:

The temperature setting for the appliance and the safety functions for its various parts are continuously monitored by a regulator controlled by a microprocessor (the MCBA). In the event of a fault, this MCBA disables the appliance and displays an error code: the screen flashes displaying **E** as the first character, followed by the error code.

To reset the appliance:

- Press **"Reset"** on the screen.
- Contact your installer if the fault happens again.

TECHNICAL CHARACTERISTICS

HeatMaster® 35 TC

Central heating		Gas Naturel	Propane
Max. Input 80/60°C	kW	34,9	
Min. Input 80/60°C	kW	10,0	
Max. output 80/60°C	kW	34,1	
Min. output 80/60°C	kW	9,8	
Efficiency 30% load [EN677]	%	108,5	
Efficiency domestic hot water mode [$\Delta t = 30^{\circ}\text{C}$]	%	105,9	

Flue gases

CO emissions max. / min. Input	mg/kWh	70 / 6	
NOx emissions max. / min. Input	mg/kWh	59 / 29	
NOx classification [EN483]		5	
Flue gas temperature — max. Input 80/60°C	°C	60	
Flue gas temperature — max. Input 50/30°C	°C	32	
Mass flow rate of combustion products	kg/h	55	
Flue gas pipe - Max. pressure drop	Pa	130	
Concentric flue gas channel maximum length \varnothing 80 / 125 mm	m	20	

Gas		G20 / G25	G31
Category [varies by country]		I 2E[S]B — I 2Er — I 2H I 2ELL — I 2L — I 2E	I 3P
Gas pressure	mbar	20 / 25	30 / 37 / 50
G20 gas flow rate	m ³ /h	3,7	
G25 gas flow rate	m ³ /h	4,3	
G31 gas flow rate	m ³ /h	—	
CO ₂ max. Input	% CO ₂	9,4	
CO ₂ min. Input	% CO ₂	9,0	

Hydraulic parameters

Max. operating temperature	°C	90	
Total capacity	L	189	
Heating circuit capacity	L	108,5	
Maximum operating pressure central heating	bar	3	
Heat exchanger pressure drop [$\Delta T = 20^{\circ}\text{C}$]	mbar	30	

Electrical connection

Class	IP	30	
Supply voltage	V/Hz	230/50	
Maximum absorbed electrical power	A	0,8	

Weight empty	kg	174	
--------------	----	-----	--

TECHNICAL CHARACTERISTICS

Natural gas categories	BE	FR	NL	LU	DE	AT - CH - CZ - DK - ES - IT - FI UK - IE - PT - SE - GR - HU
I 2 E(S)B [G20] 20 mbar – [G25] 25 mbar	●					
I 2 Er [G20] 20 mbar – [G25] 25 mbar		●				
I 2 L [G25] 25 mbar			●			
I 2 E [G20] 20 mbar				●		
I 2 ELL [G20] 20 mbar – [G25] 20 mbar					●	
I 2 H [G20] 20 mbar						●

Propane categories	DK - NL NO - IT	BE - CH - ES FR - UK - IE PT - FI - SE IT - GR	AT - CH CZ - ES NL - DE LU - HU	BE - CH ES - FR UK - IE IT - PT	PT	CZ - DK - ES FI - FR - UK IE - IT - NL NO - PT - SE	AT - CH CZ - DE FR
I 3 P [G31] 30 mbar	●						
I 3 P [G31] 37 mbar		●					
I 3 P [G31] 50 mbar			●				
I 3 + [G30 + G31] 28 - 30 / 37 mbar				●			
I 3 + [G30 + G31] 50 / 67 mbar					●		
I 3 B [G30] 28 / 30 mbar						●	
I 3 B [G30] 50 mbar							●

DOMESTIC HOT WATER FEATURES

		HeatMaster® 35 TC
Operating conditions at 80°C		
Peak flow at 40°C [ΔT = 30°C]	L/10'	419
Peak flow at 40°C [ΔT = 30°C]	L/60'	1312
Constant flow at 40°C [ΔT = 30°C]	L/h	1057
Peak flow at 45°C [ΔT = 35°C]	L/10'	381
Peak flow at 45°C [ΔT = 35°C]	L/60'	1080
Constant flow at 45°C [ΔT = 35°C]	L/h	898
Peak flow at 60°C [ΔT = 50°C]	L/10'	224
Peak flow at 60°C [ΔT = 50°C]	L/60'	692
Constant flow at 60°C [ΔT = 50°C]	L/h	578
Pre-heat time	minutes	37

ELECTRICAL CONNECTION

WIRING DIAGRAM : HeatMaster® 35 TC



- 1. Power supply 230 V
- 2. ON/OFF switch
- 3. Boiler shunt pump
- 4. Heating pump (optional)
- 5. Gas valve rectifier
- 6. 230Volt - 24Volt transformer
- 7. MCBA
- 8. Display
- 9. Water pressure switch
- 10. Fan PWM control
- 11. Summer/Winter switch
- 12. NTC1 flow sensor
- 13. NTC2 return sensor
- 14. NTC5 flue gas temperature
- 15. Room thermostat (optional)
- 16. NTC3 domestic hot
- 17. NTC4 outdoor temperature (optional)
- 18. NTC6 second heating circuit flow sensor (optional)
- 19. Zero volt of 24V circuit.
- 20. Safety contact thermostat RAM (optional)
- 21. Ionisation and ignition cable

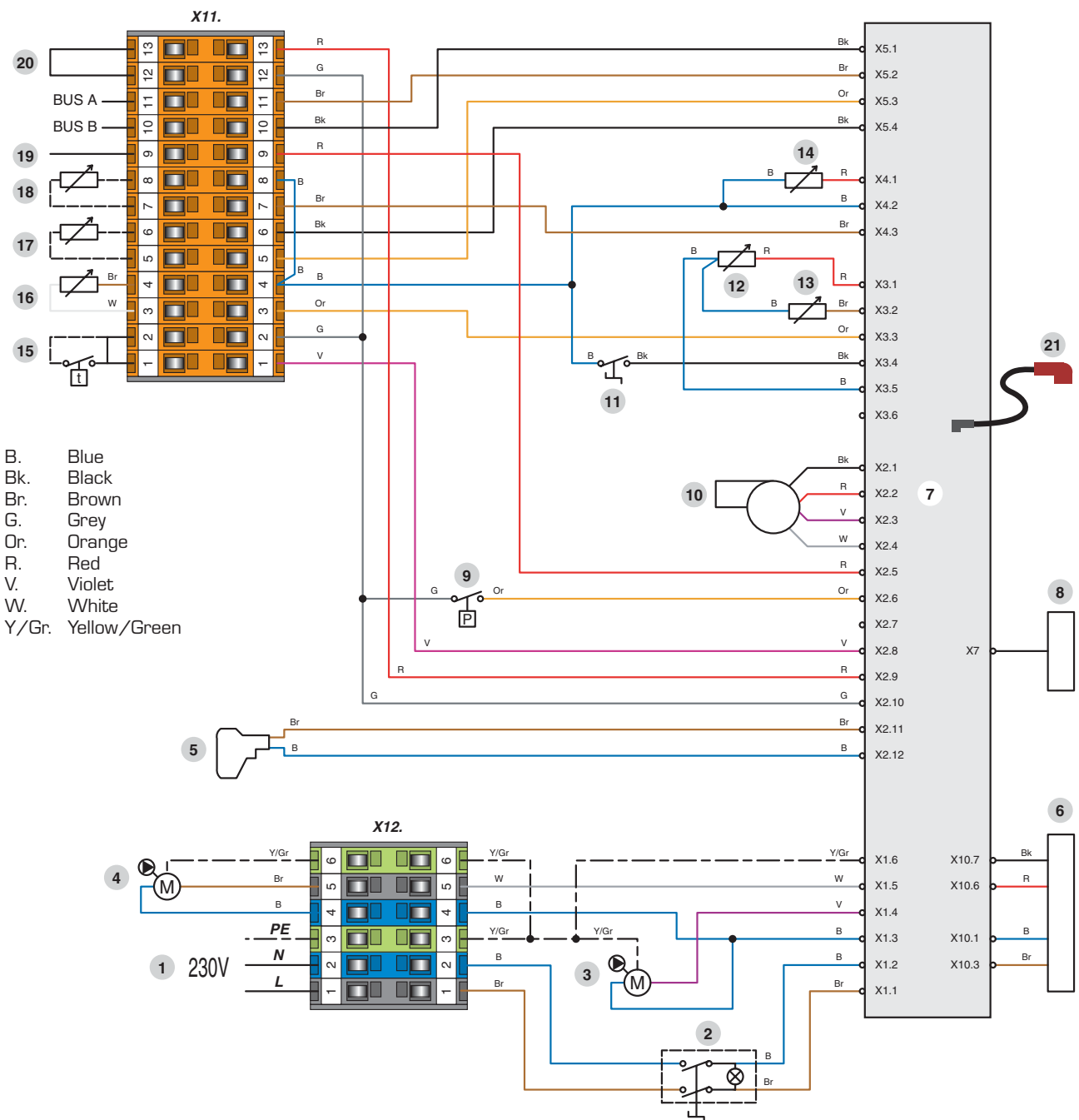

INSTALLATION INSTRUCTIONS

DIMENSIONS

HeatMaster® 35 TC

A mm	1720
B mm	600
C mm	500
D mm	80
E mm	125
F mm	140
G mm	1700
H mm	670
I mm	110
J mm	100
K mm	200
L mm	960
M mm	170
N mm	230
Weight when empty [kg]	174

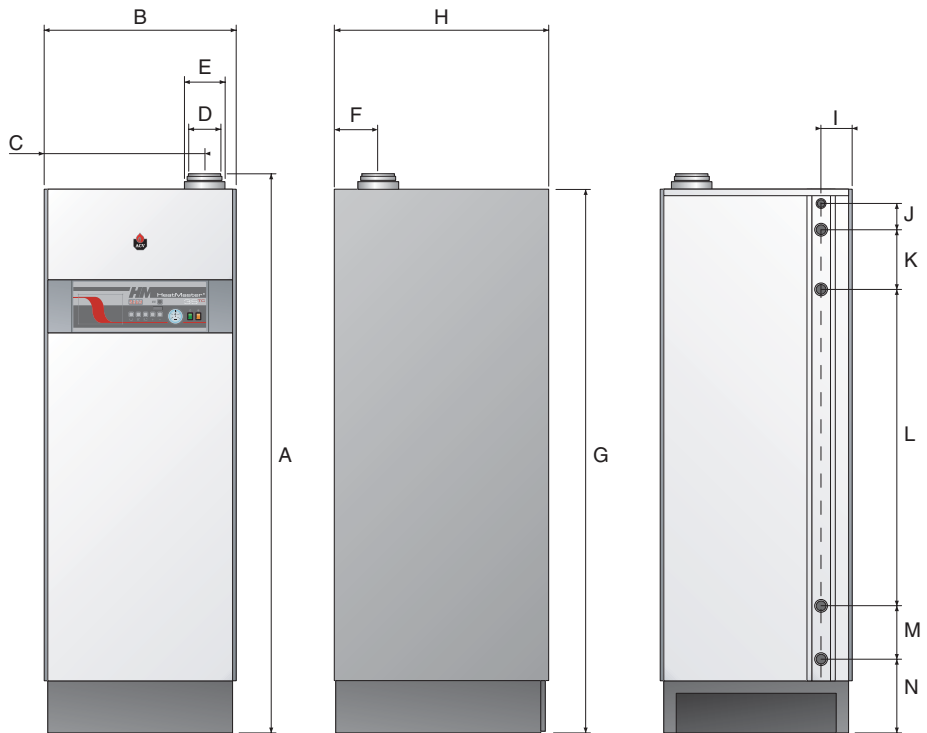

BOILER ROOM

- Make sure that all air vents are unobstructed any times.
- Do not store any flammable products in the boiler room.
- Do not store any corrosive products, paint, solvents, salts, chlorine products and other detergent products near the appliance.
- If you smell gas, do not switch on any lights, turn off the gas tap at the meter, ventilate the rooms and contact your installer.

ACCESSIBILITY

The appliance must be positioned in such a way to be accessible any time. In addition, the following distances are required around the appliance.

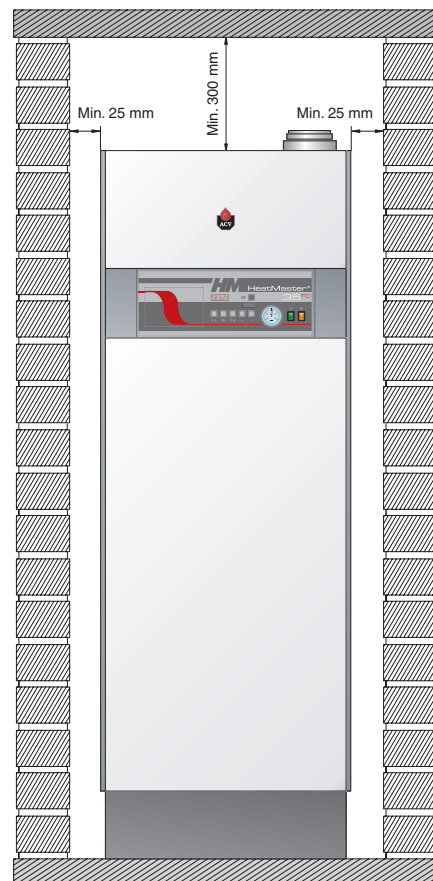

INSTALLATION

CONNECTION TO THE CHIMNEY

- The chimney connections must comply with the applicable standards (in Belgium: NBN D51-003), the local energy supplier's instructions, the fire regulation and neighbourhood good practices.
- The **HeatMaster® TC** has an inbuilt gas/air ratio regulator, which makes it largely independent of the pressure drop in the air intake and flue gas extraction system. However, the maximum pressure drop for this system may not be exceeded, or the pressure will diminish. Nevertheless, the gas/air ratio regulator continuously guarantees optimum combustion with very low emission levels.
- The horizontal flue gas pipes must always be installed with a min. slope of 5 mm per meter, upwards from the boiler side.
- There must be no obstruction or openings for any other appliances within a radius of 0.5 metres around the flue terminal of the **HeatMaster® TC**.
- **The maximum flue resistance is 130 Pascal.** You can use the following table as the basis for calculating this value (*please also refer to the specimen calculation presented under the table*).

Table of flue resistance in Pascal

[1 Pascal = 0,01 mbar]

	Pipe concentric Ø 80/125 mm	Air inlet separate Ø 80 mm	Air extraction separate Ø 80 mm
1 m straight pipe	5.0	1.5	2.0
Pipe with a monitoring section	2.5	—	1.0
90° pipe bend	6.0	1.9	3.4
45° pipe bend	4.0	1.3	2.3
Vertical pipe	20.0	—	—
Horizontal pipe	15.0	—	—

This table is based on the equipment offered by ACV and cannot be applied generally.

Options for connection to the chimney

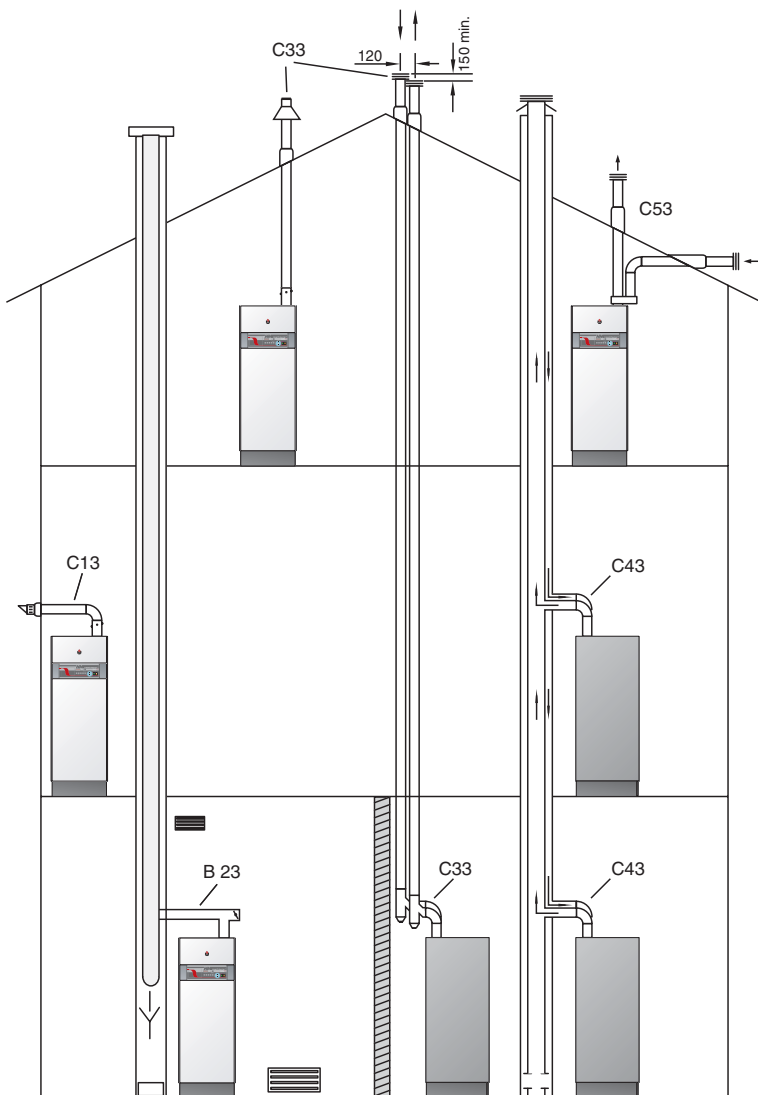

Sample calculation:

The diagram below consists of the following parts: pipe with monitoring section + 2 * 90° pipe bends + 2 metres of horizontal pipe + 2 * 45° pipe bends + (2 + 1 + 1) metres of vertical pipe and fall back + discharge.

Therefore, the resistance of this system is as follows:

$$2.5 + (2 \times 6.0) + (2 \times 5.0) + (2 \times 4.0) + (4 \times 5.0) + 20 = 72.5 \text{ Pa.}$$

This value is less than the maximum authorised resistance, therefore the installation is compliant.

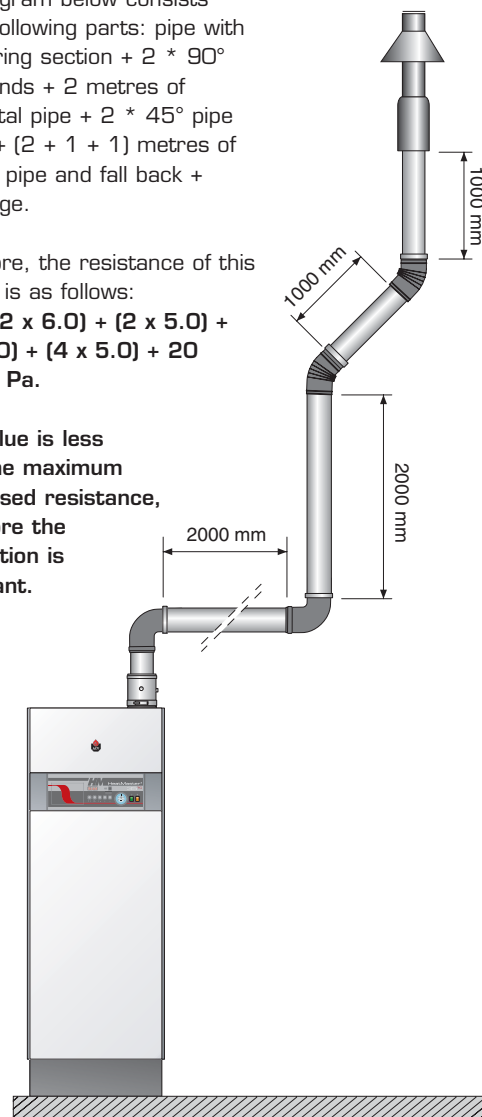

INSTALLATION

CONNECTION TO THE GAS

- The Prestige is fitted with a 3/4" male fitting connector, on which you can connect the gas tap.
- You must comply with the applicable regulations (e.g. NBN D51-003) for gas connections, and the other standards in force in the country of installation.
- Where there is a risk of dirt stemming from the network, place a gas filter upstream from the connection.
- Drain the gas pipe and check in minute detail that all the boiler pipes, both inside and outside, are sealed.
- Check the gas pressure in the system. Consult the technical characteristics.
- Check the gas pressure and consumption when commissioning the appliance.

DOMESTIC HOT WATER CONNECTION

The **HeatMaster® TC** boiler can be connected directly on the domestic hot water circuit.

Flush out the system before connecting the domestic hot water part.

The installation must be fitted with an approved safety unit with a 7-bar safety valve, a non-return valve and a shut-off valve.

During the heating process, the domestic hot water dilates and the pressure increases. As soon as the pressure exceeds the safety valve setting, the valve opens and discharges a small quantity of water. Using a hot water expansion vessel (2 litres at least) will prevent this phenomenon and reduce water hammer effect.



⚠ DANGER The hot water output temperature may reach temperatures in excess of 60°C, which can cause burns. We therefore recommend that you install a thermostatic mixer immediately after installing the appliance.



If stop valves are used in the domestic hot water system, they can cause pressure waves when closed. Use devices designed to reduce water hammer to avoid this phenomenon.

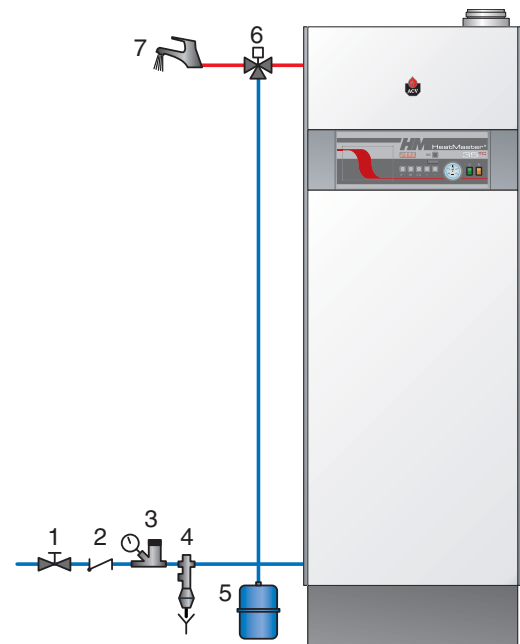

1. Cold water supply tap
2. Non-return valve
3. Pressure reducing valve
4. Safety group
5. Hot water expansion vessel
6. Thermostatic mixer
7. Drawoff tap

HEATING CONNECTIONS

Recommendations

- The central heating system must be completely flushed out with tap water before connecting the boiler.
- The central heating safety valve is incorporated under the appliance and must be routed to the drain with an open connection (to allow inspection).
- A temperature homogenisation pump fits the boiler. That pump runs aswell during hot water mode aswell in heating mode. The speed selection of the pump must be set to 3.
- Fill the system with fresh water. Contact your ACV representative about the use of inhibitors.
- **It is possible that the pumps are locked due to the presence of residual water from tests completed on the appliance. Therefore, we recommend that the pumps is locked before filling the appliance.**
- You will find the connection for the filling valve and/or drainage valve on the bottom of the appliance. Fill the appliance to a minimum pressure of one bar. Drain the whole system and re-fill the appliance to a pressure of 1,5 bar.
- Fit the condenstrap, fill it with tap water and connect the hose to the drain using a connection with an inspection section. Make sure you prevent the freezing of the condensates.

HEATING CONNECTIONS : GENERAL

1. Isolating valve, heating system
2. Safety valve calibrated to 3 bar, with pressure gauge
3. System filling valve
4. Expansion vessel
5. Drain cock
6. Condenstrap
7. Heating pump

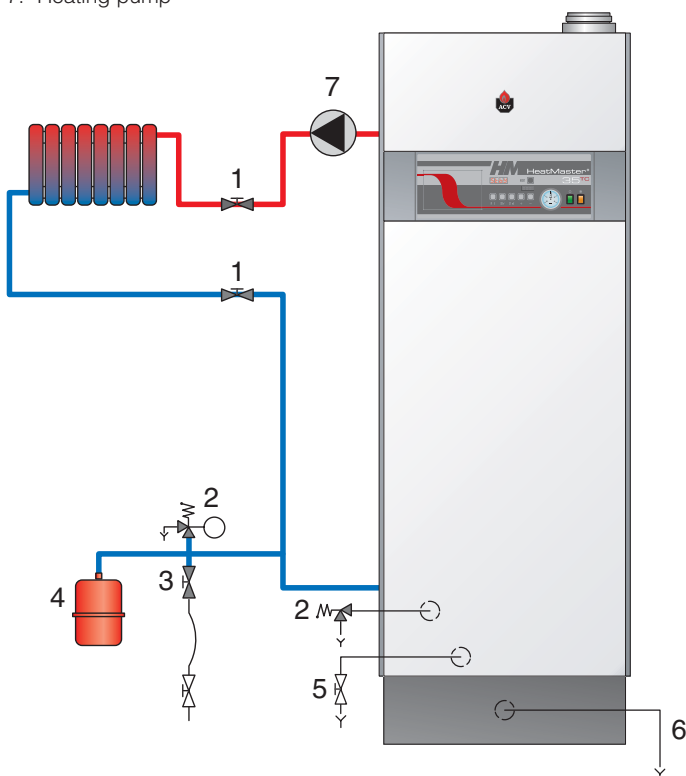

INSTALLATION

INSTALLATION OF A SINGLE HIGH TEMPERATURE CIRCUIT WITH ROOM THERMOSTAT ACV 15 CONTROL



General diagram

The On/Off room thermostat controls the central heating system (radiators only).







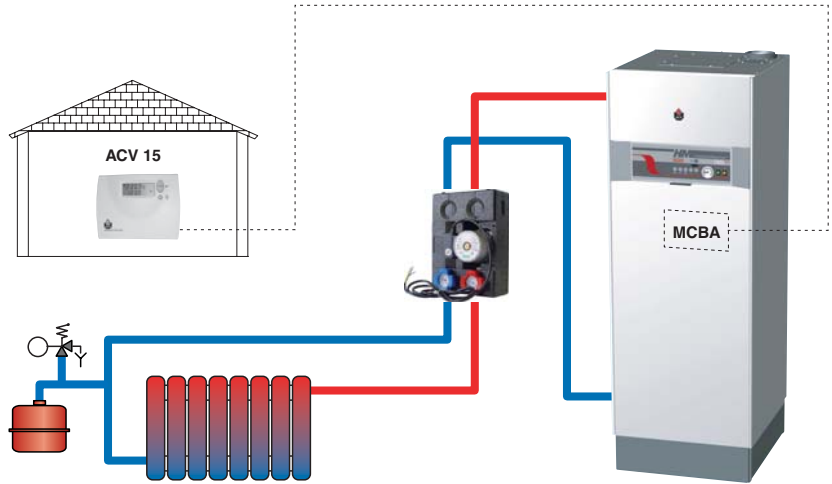
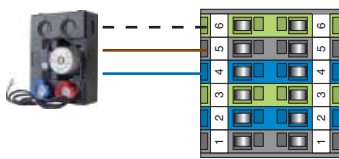
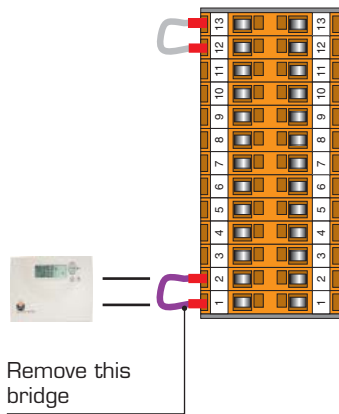

The pump is powered as soon as the room thermostat generates an heat demand.

Advantages for the user:

- Simplicity of the system
- Direct connecton to existing installations

Optional accessories	
Code	Description
	10800018 Room thermostat ACV 15
	10800097 High temperature kit DN20 Including: one circulation pump, two isolating valves, check valve, two thermometers



Factory setting	Typical setting	Description
		00 : Heating mode "OFF" 01 : Heating mode "ON"
		Setting temperature for the heating water (adjustable between 30 and 85°C).
		00 : Using a outside temperature sensor and a room thermostat
		

INSTALLATION

INSTALLATION OF A WEATHER DEPENDENT HEATING CIRCUIT HIGH OR LOW TEMPERATURE

General diagram





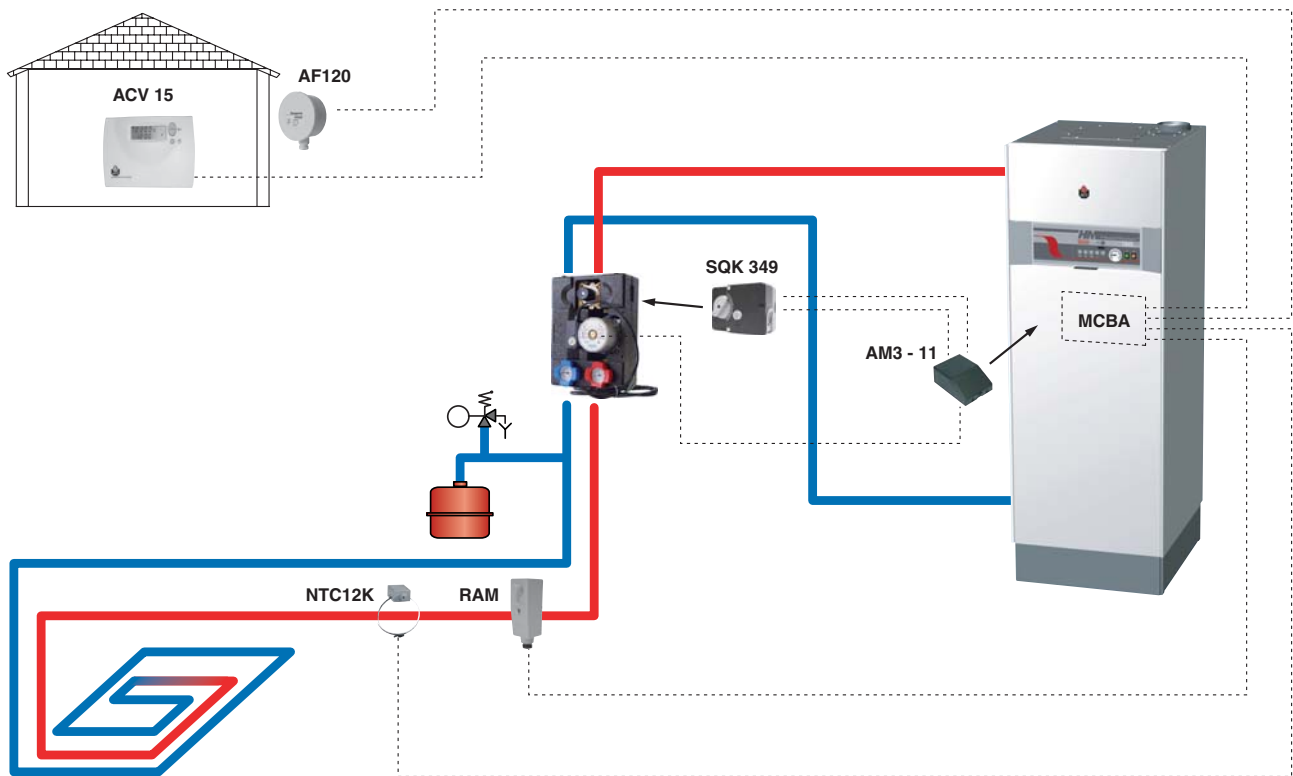

This is a simple way to control two heating circuits (radiators or floor heating) with weather depending control.

Advantages for the user:

- Comfort
- Efficiency



Optional accessories

Code	Description	Code	Description
 10800018	Room thermostat ACV 15	 10510100	Outside temperature sensor 12kΩ — AF120
 10800095	AM3-11 module : Controls the second heating circuit - communicates directly with the MCBA	 10800152	Low temperature kit DN20 Including: one circulation pump, two isolating valves, check valve, two thermometers, the 3-way valve with integrated bypass.
 537D3040	Contact sensor 12kΩ To be mounted on the outlet of controlled circuit	 10800019	Servomotor SQK 349 : Electromechanical servomotor SQK 349 for the three-way valve included in low temperature kit (opening times : 150 seconds)
 10510900	Contact thermostat RAM 5109 : Required to protect all floor heating circuits		

INSTALLATION

To be wired in accordance with the applicable regulations.

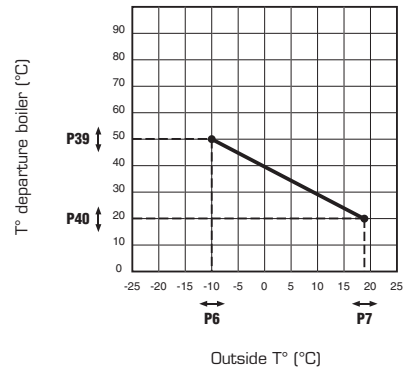
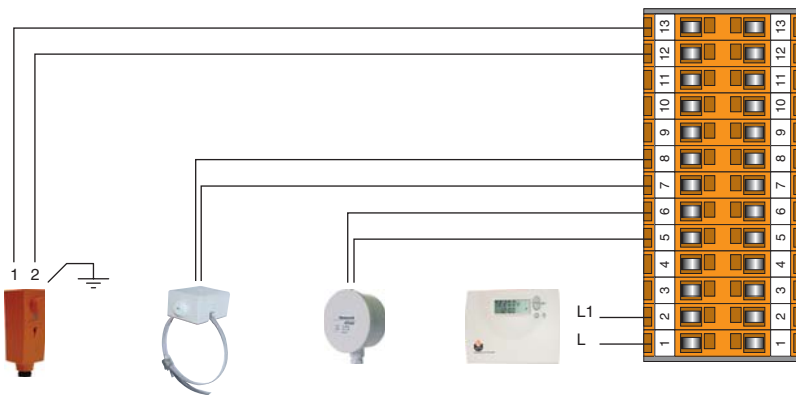
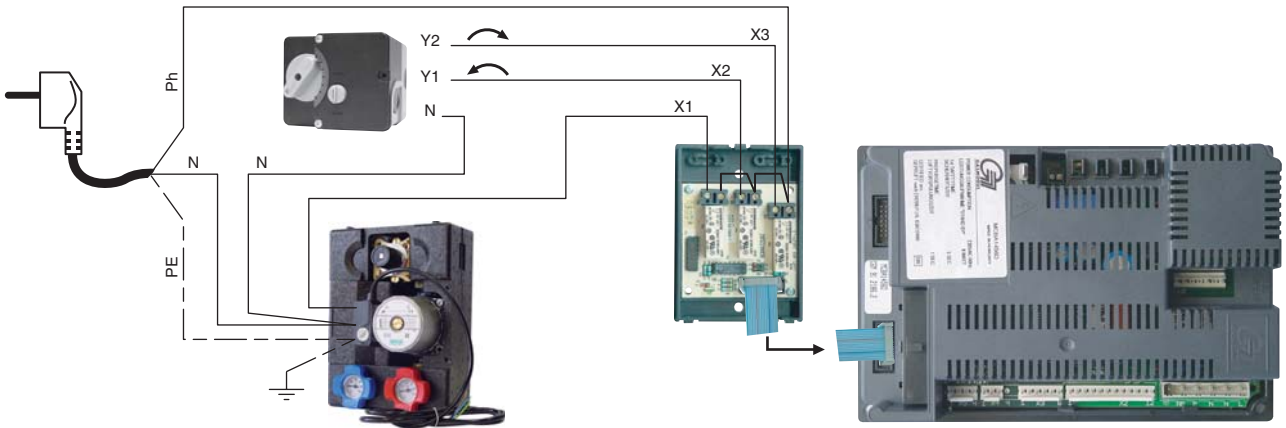

PARA
Factory setting

PARA
Typical setting

Description

1.60	1.60	Maximum setpoint in domestic hot water mode
2.01	2.01	00 : Domestic hot water mode "OFF" 01 : Domestic hot water mode "ON"
3.01	3.01	00 : Heating mode "OFF" 01 : Heating mode "ON"
4.85	4.85	Maximum temperature of the heating circuit (must be higher than hot water setpoint)
P.06	P.06	Minimum outside temperature [T4] (adjustable between -20 and 10°C).
-10	-10	
P.07	P.07	Maximum outside temperature [T4] (adjustable between 15 and 25°C).
18	18	
P.34	P.34	10 : Heating pump controlled by room thermostat - hot water priority active 21 : Heating pump runs continuously - hot water priority active 50 : Heating pump controlled by room thermostat - hot water priority not active 61 : Heating pump runs continuously - hot water priority not active
00	00	
P.39	P.39	
50	50	
P.40	P.40	Minimum temperature of the heating circuit
20	20	

INSTALLATION

INSTALLATION OF TWO HEATING CIRCUIT CONTROLLED BY CONTROL UNIT AND ZMC-1 MODULE

General diagram

This configuration controls two heating circuits (radiators or floor heating). In addition, the Room unit features a remote monitoring of the two circuits







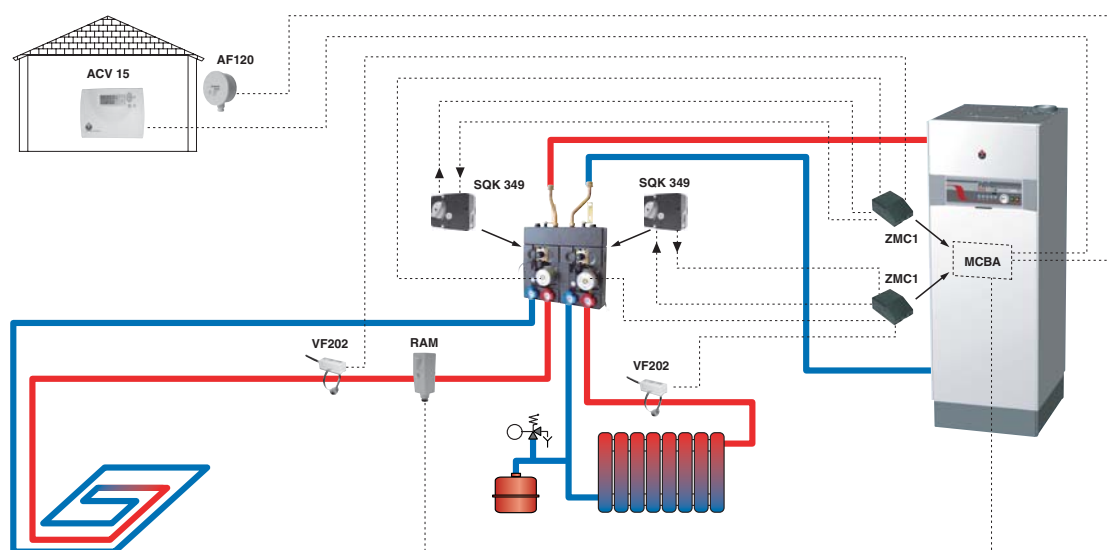

You can adjust those two circuits depending on the outside temperature.

This is the ideal configuration for floor heating with additional heating provided by radiators.

You can select various heating functions, and program up to three weekly schedules, as well for the central heating as for the hot water production.



Optional accessories

Code	Description	Code	Description
 10800034	Room Unit RSC Supplied with outside temperature sensor	 10510100	Outside temperature sensor 12kΩ — AF120
 10800119 X2	ZMC-1 module (kit) : Controls the second heating circuit - alarm contact - operates only in conjunction with the Room Unit RSC.	 10800077	Collector 2 circuits DN20 : With bypass, connecting tubes and integrated wall brackets
 10800036	Clip-in interface RMCIEBV3 Enables communications between the MCBA and the Room Unit RSC.	 10800152 X2	Low temperature kit DN20 Including: one circulation pump, two isolating valves, check valve, two thermometers, the 3-way valve with integrated bypass.
 10800045 X2	Contact sensor 2kΩ — VF202 : To be mounted on the outlet of controlled circuit	 10800019 X2	Servomotor SQK 349 : Electromechanical servomotor SQK 349 for the three-way valve included in low temperature kit (opening times : 150 seconds)
 10510900	Contact thermostat RAM 5109 : Required to protect all floor heating circuits		

INSTALLATION

To be wired in accordance with the applicable regulations.

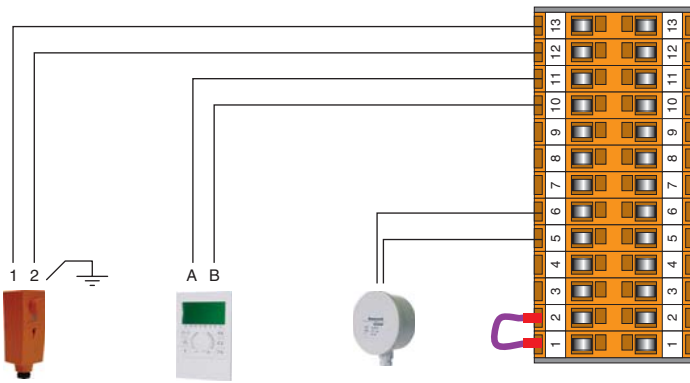
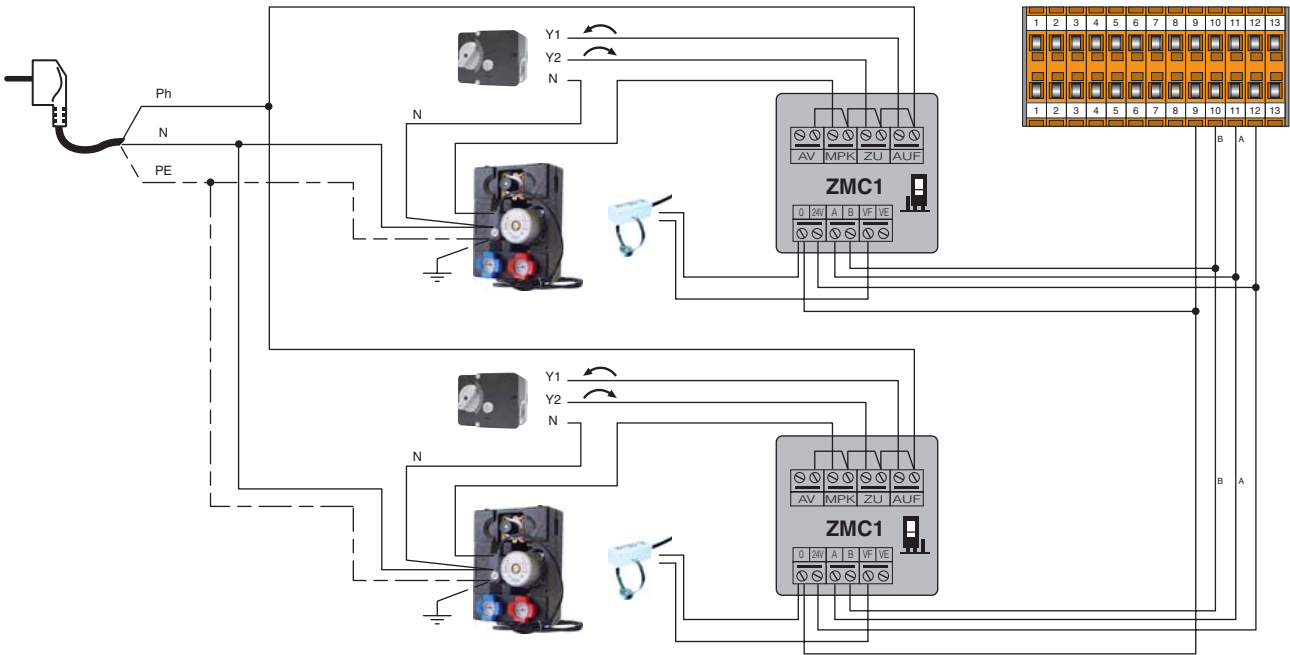

10800036: Interface address "0"

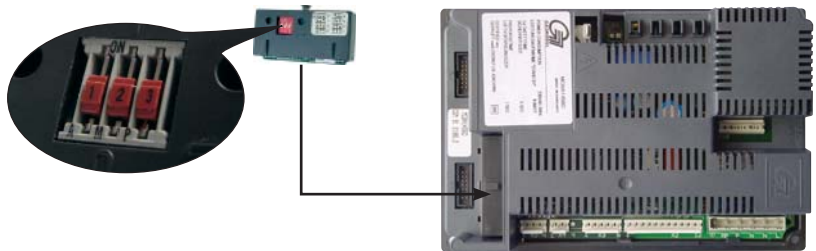
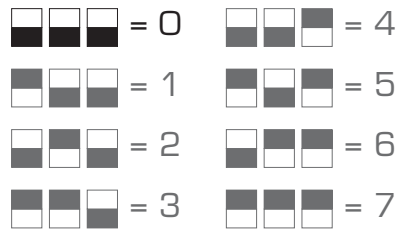

PARFA Factory setting	PARFA Typical setting	Description
1.60	1.60	Maximum setpoint in domestic hot water mode
2.01	2.01	00 : Domestic hot water mode "OFF" 01 : Domestic hot water mode "ON"
3.01	3.01	00 : Heating mode "OFF" 01 : Heating mode "ON"
4.85	4.85	Maximum temperature of the heating circuit (must be higher than hot water setpoint)

COMMISSIONING AND MAINTENANCE

COMMISSIONING THE SYSTEM



- Slowly fill the tank and drain it by opening a hot water tap. Drain all the taps and check that there are no leaks in the domestic hot water system.
- Fill the whole system up to a minimum pressure of 1 bar (preferably 1.5 bar), using the boiler's fill valve. Fill the system slowly. Also check that the automatic air vent on the tank is working. Check that there are no leaks in the central heating system.
- To vent the homogenisation pump.
- Open the gas valve, drain the pipe and check that there are no leaks in the system.
- Place the condensing trap on the bottom face of the boiler and check it is fill with water.
- Connect the plug to the wall socket and power on the appliance. If needed, place the room thermostat to its highest position. The boiler should start. Check the gas pressure and allow the boiler to heat up for a few minutes. Set the boiler to High Power mode and check the CO₂ level (*see the table of Technical Characteristics*). Then, set the boiler to Low Power mode and check the CO₂ level again (*see the table of Technical Characteristics*).
- Set the central heating and hot water temperatures following the values given in the Directions for Use.
- Drain the central heating system again and, if necessary, re-fill it.
- Make sure the central heating system is correctly balanced and, if necessary, adjust the valves to prevent a greater or lesser flow than planned to some circuits or radiators.

CHECKING THE SETTINGS

- Check that the parameters are set in accordance with the user's needs: see page 3, Directions for Use.
- Check the boiler settings: this task can only be carried out by an ACV-trained installer or by the ACV maintenance department.
- Set the appliance to High Power mode by simultaneously pressing the mode and Plus keys.
- Check the dynamic gas pressure at the gas valve (*see diagram below, ref. 1*). This must be at least 18 mbars. Wait a few minutes for the appliance to heat up to a minimum temperature of 60°C. Check the CO₂ setting using a measurement instrument. Please see in the Technical Characteristics for optimum value. To increase the CO₂ value, turn the venturi screw counterclockwise; turn it clockwise to reduce the value (*see diagram below ref. 2*). Then put the appliance to High Power mode by simultaneously pressing the mode and Plus keys. Wait a few minutes to stabilise. Check the CO₂ value. It should be either equal to the full power value or a maximum of 0.5% less than this value. If you record a significant deviation, please contact the ACV maintenance department.

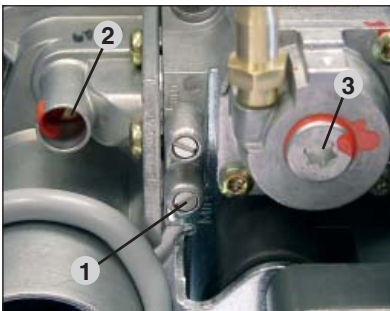

Réf. 3:
The gas valve offset setting is a sealed factory setting. In principle, it may not be modified.

INSPECTION AND MAINTENANCE



ACV recommends that you have your boilers inspected and cleaned if need be at least once a year.

Plug out the appliance before undertaking any work, even if only recording measurements and adjusting the settings.

- Check that the siphon is not fouled, fill it, if need be, and check that there are no leaks.
- Check that the safety valves are operating correctly.
- Drain the whole system and if necessary re-fill the appliance to pressure of 1.5 bar.



If you have to refill your circuit more than twice a year, please contact your installer.

- Check the boiler charge in High Power mode. If there is a big difference between this value and the original setting, the deviation could mean a blockage in the air intake pipes or flue gas extraction pipes, or that the exchanger has become fouled with an accumulation of dirt.

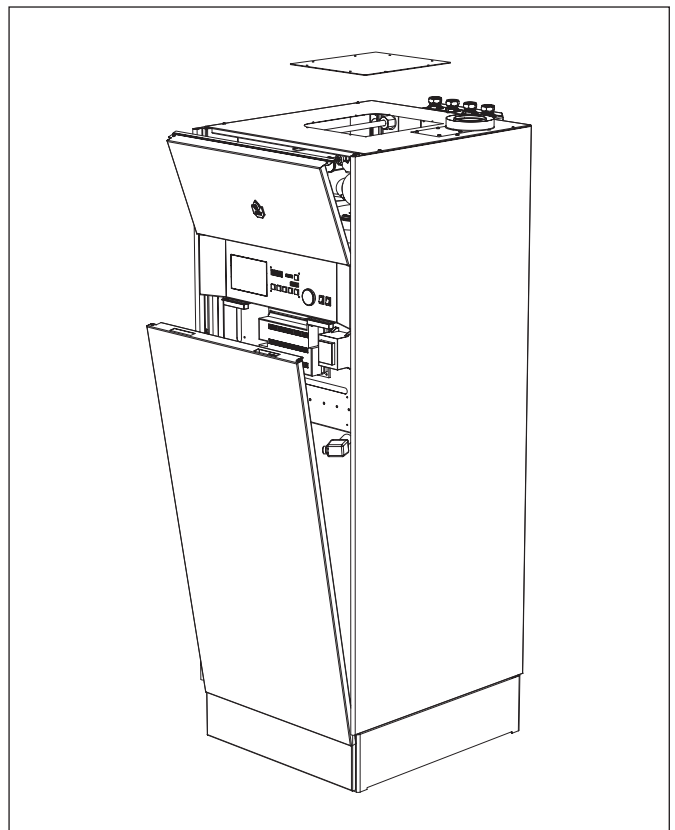

DISASSEMBLING THE BURNER

- Close the inlet gas valve.
- Remove the top panel of the boiler.
- Unplug the fan plugs (24 Volt), the ignition cable, the gas valve control and the ignition electrode earth.
- A part of the upper jacket panel is removable for an easier access.
- Loosen the 4 burner nuts using a ratchet wrench.
- Unscrew the three-way coupling on the gas pipe.
- In one unit, lift up the burner with the fan and the gas valve to remove them from the exchanger. Be careful not to damage the burner insulation in the exchanger.
- Check the condition of the insulation and the seals and replace them if necessary before re-assembling the burner following the same procedure but in the reverse order.

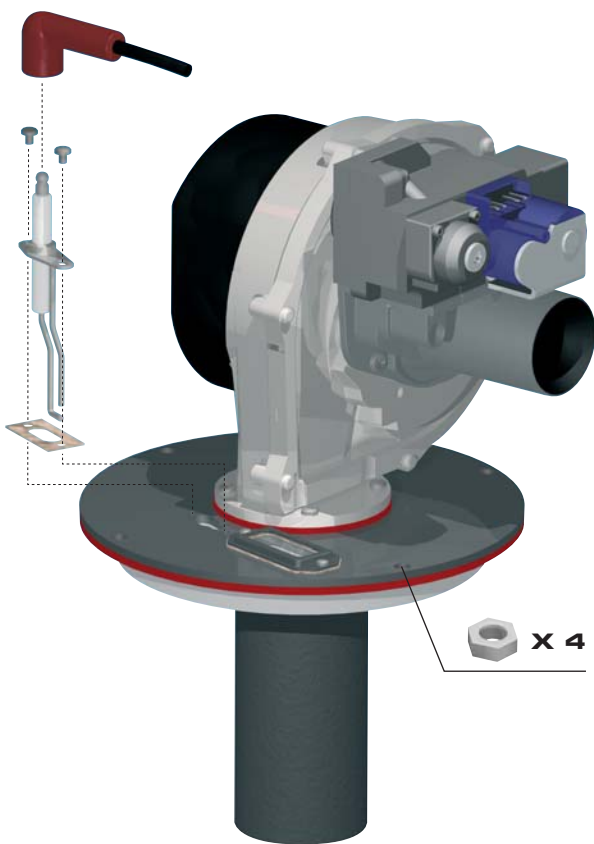

CLEANING THE HEAT EXCHANGER

- Remove the burner assembly as described above.
- Remove the burner gasket.
- Clean the combustion chamber using a vacuum cleaner.
- It could be necessary to clean the flue tubes by putting water in the combustion room. After that operation, it is necessary to clean the condensing trap.
- Check the burner insulation and the burner gasket; replace the parts if necessary.
- Check the igniter, replace if necessary
- Reassemble the burner and check for leakages.
- Power up the appliance, set the boiler in full power mode and recheck for leaks.
- Check the gas pressure and the CO₂ level as explained in previous paragraf.

TEMPERATURE SENSOR RESISTANCE TABLES

T° [°C]	R Ω	T° [°C]	R Ω	T° [°C]	R Ω
- 20	98200	25	12000	70	2340
- 15	75900	30	9800	75	1940
- 10	58800	35	8050	80	1710
- 5	45900	40	6650	85	1470
0	36100	45	5520	90	1260
5	28600	50	4610	95	1100
10	22800	55	3860	100	950
15	18300	60	3250		
20	14700	65	2750		

DISASSEMBLING AND CHECKING THE ELECTRODE

- Remove the ignition cable.
- Remove the two fixing screws.
- Remove the electrode earth but make sure the serrated washer is fixed between the earth cable and the electrode when re-assembling.
- Check the condition of the seals and replace them if necessary before re-assembling the electrode following the same procedure but in the reverse order.

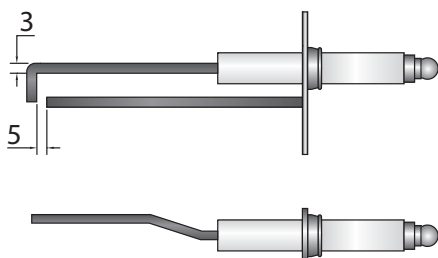

MCBA PARAMETERS FOR THE SPECIALIST

STANDBY MODE

Standby Mode

5t64

After you power down the appliance the screen displays Pilot mode, as shown in the figure above.

This is the standard MCBA mode. The MCBA automatically returns to this mode after 20 minutes if no keys have been pressed on the screen. Any parameters that were modified are then enabled.

The first character shows the current status of the boiler depending on the condition of both the boiler and the burner. The last 2 characters indicate the start temperature.

Once the cause of the blockage has been resolved, the burner starts automatically within 150 seconds at most.

Status	Boiler function
0 3 8 8	Standby, no demand for heat
1 3 8 8	Fan first, fan after
2 3 8 8	Ignition
3 3 8 8	Operation of the boiler burner for the heating
4 3 8 8	Operation of the boiler burner for the domestic hot water
5 3 8 8	Air pressure limit or obtaining the number of start revolutions
6 3 8 8	The burner goes out when the specified value is reached. A demand for heat is present nonetheless.
7 3 8 8	Pump over-run time after the demand for central heating
8 3 8 8	Pump over-run time after the demand for domestic hot water
9 3 8 8	Burner blocked: <ul style="list-style-type: none"> • 6 1 8 : T1 > 95°C • 6 1 9 : T2 > 95°C • 6 2 4 : T2 - T1 > 10°C after 90 seconds • 6 2 5 : dT1/dt > maximum gradient T1 • 6 2 6 : water pressure switch not off • 6 2 8 : no fan signal • 6 2 9 : erroneous fan signal • 6 3 0 : T1 - T2 > Δ max. • 6 3 3 : NTC3 short-circuit • 6 3 5 : NTC5 short-circuit • 6 3 8 : NTC3 interrupt • 6 4 0 : NTC5 interrupt • 6 5 2 : T5 > T5 max • 6 6 5 : wait for the fan to start

Status	Boiler function
A 3 8 8	Internal check — three-way valve
C 3 8 8	Boiler burner in hot water ready function
H 3 8 8	Test function: Central heating high power
L 3 8 8	Test function: Central heating low power
E 3 8 8	Test function: Boiler with fixed number of revolutions

If the burner is blocked for one of the reasons mentioned above, the screen display alternates between a 9 followed by the temperature (two last digits) and b with the error code.

MCBA PARAMETERS FOR THE SPECIALIST

SETTING THE MCBA PARAMETERS



Parameter Mode 













To access Parameter mode when the system is in Pilot mode, press **MODE** once.

To scroll through the list of parameters, simply press "**step**". To modify a parameter value, use the + or - keys.

Then press "**Store**" to save the value you just changed. The screen flashes once to confirm the data has been saved.

To activate the parameters you changed, press **MODE** once more (which brings you into Info mode). However, if you do not press a key, the system returns to Pilot mode after 20 minutes and automatically enables the changes.

Key	Screen
 MODE	

Key	Screen	Description of parameters	Factory setting
			HeatMaster® 35 TC
 STEP		Adjusting the hot water temperature	
 STEP		Production of hot water 00 = Stop 01 = Start 02 = Stop + pump continuously on 03 = Start + pump continuously on	
 STEP		Turn On/ Turn Off the heating 00 = Stop 01 = Start 02 = Stop + pump continuously on 03 = Start + pump continuously on	
 STEP		Maximum temperature in Central Heating mode	



MCBA PARAMETERS FOR THE SPECIALIST

REQUEST FOR INFORMATION ON THE INSTALLATION











Info Mode

INFO

To switch from Standby to Info mode, press **Mode** twice.

Key	Screen
	PARA
MODE	
	INFO
MODE	

Press **STEP** until the system displays the information you need. The point located behind the first position flashes to indicate that the boiler is in **INFO** mode.

Key	Screen	Description of parameters
	1.80	Boiler temperature T1
STEP		
	2.50	Boiler temperature T2
STEP		
	3.65	Hot water temperature T3 in °C
STEP		
	4.03	Outdoor temperature T4 in °C
STEP		
	5.55	Flue gas temperature
STEP		
	6.45	Boiler temperature calculated in °C
STEP		
	7.00	Rate of increase in the start temperature in °C/s
STEP		
	8.00	Rate of increase in the return temperature in °C/s
STEP		
	9.00	Rate of increase in the hot water temperature in °C/s
STEP		
	A.34	Flow temperature of the heating circuit (with module AM3-11 only)
STEP		

ENTERING THE CODE

Code Mode

CODE

You can access the following parameters by entering the service code:

- Parameters 5 - 42
- Communication mode
- Fan Speed mode
- ERROR mode

STBY

To access Code mode, press **MODE** and **STEP** simultaneously [only from Standby mode!].

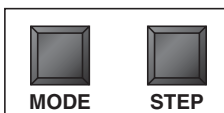

→ CODE

Press **STEP** once and the system displays **C** in position 1, followed by arbitrary characters in positions 3 and 4.



→ C 8 8

Press + or - to change the code.

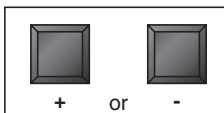

→ C 8 8

Press **STORE**, the screen flashes briefly to indicate that the code has been accepted.



→ C 8 8

Press **MODE** until the system displays the correct mode.













 Only ACV authorised installers know the access code.

For further information, please contact our after-sales department.

MCBA PARAMETERS FOR THE SPECIALIST

MCBA PARAMETERS WITH CODE RESTRICTED ACCESS

Factory setting

Key	Screen	Description of parameters	HeatMaster® 35 TC
 STEP	P.05	Minimum temperature of the top part of the boiler in heating mode when using an outdoor sensor de la chaudière In order to avoid cycling between heating and hot water mode, it is preferable to set that parameter higher than 60°C.	60
 STEP	P.06	Minimum outdoor temperature [adjust the heating curve]	-10
 STEP	P.07	Maximum outdoor temperature [adjust the heating curve]	18
 STEP	P.08	Frost protection temperature	-30
 STEP	P.09	Correction based on the outdoor temperature	00
 STEP	P.10	Blockage T 0 = Disabled	00
 STEP	P.11	Acceleration time lag 00 = Stop [minute]	00
 STEP	P.12	Night set back heating (°C)	10
 STEP	P.13	Maximum number of fan revolutions in CH mode [rpm x 100]	Natural gas 63
	Propane 63		
 STEP	P.14	Maximum number of fan revolutions in CH mode [rpm /min.]	Natural gas 00
	Propane 00		
 STEP	P.15	Max. number of revs in domestic hot water mode [rpm x 100]	Natural gas 63
	Propane 63		
 STEP	P.16	Maximum number of fan revolutions in domestic hot water mode [rpm]	Natural gas 00
	Propane 00		
 STEP	P.17	Minimum number of fan revolutions [rpm x 100]	Natural gas 20
	Propane 20		

MCBA PARAMETERS FOR THE SPECIALIST

Factory setting

Key	Screen	Description of parameters	HeatMaster® 35 TC
STEP	P.818	Minimum number of fan revolutions [rpm]	Gaz naturel
			Propane
STEP	P.819	Number of fan revolutions at ignition [rpm x 100]	Gaz naturel
			Propane
STEP	P.820	CH pump over-run 0 = 10 sec. [step = 1 minute]	
STEP	P.821	Domestic hot water pump over-run time [step = 10.2 sec]	
STEP	P.822	Central Heating modulation hysteresis enabled	
STEP	P.823	Central Heating modulation hysteresis disabled	
STEP	P.824	Domestic hot water modulation hysteresis enabled	
STEP	P.825	Domestic hot water modulation hysteresis disabled	
STEP	P.826	Detection of domestic hot water hysteresis enabled	
STEP	P.827	Detection of domestic hot water hysteresis disabled	
STEP	P.828	Central Heating blockage time [sec. x 10,2]	
STEP	P.829	Domestic hot water blockage time [sec. x 10,2]	
STEP	P.830	Domestic hot water <input type="checkbox"/> Central Heating blockage time [sec. x 10,2]	







MCBA PARAMETERS FOR THE SPECIALIST

			Factory setting
Key	Screen	Description of parameters	HeatMaster® 35 TC
 STEP		Re-modulate the difference T1 - T2	
 STEP		Shell address [-1 = disabled]	
 STEP		Temperature increase set point for the production of hot water	
 STEP		00 : High temperature circuit - heating pump controlled by room thermostat - hot water priority active 10 : Controlled circuit (outside sensor + AM3-11 module) - heating pump controlled by room thermostat - hot water priority active 21 : Controlled circuit (outside sensor + AM3-11 module) - heating pump runs continuously - night reduction possible - hot water priority active 50 : Controlled circuit (outside sensor + AM3-11 module) - heating pump controlled by room thermostat - hot water priority not active 61 : Controlled circuit (outside sensor + AM3-11 module) - heating pump runs continuously - night reduction possible - hot water priority not active	
 STEP		Selection of the type of hot water production - That parameter is fixed in a HeatMaster® TC and must not be changed	
 STEP		Manual fan number of revolutions	
 STEP		First position: Fan control pump level during burning in Second position: Fan control pump level during over-run time	
 STEP		Hold temperature	
 STEP		Maximum temperature for the start heating curve for the 2nd circuit	
 STEP		Minimum temperature for the start heating curve for the 2nd circuit	
 STEP		2nd circuit temperature hysteresis	
 STEP		First position: Special pump [0 = disabled] Second position: Minimum disable cycle [0 = disabled]	





MCBA PARAMETERS FOR THE SPECIALIST

COMMUNICATION MODE [with code]

When in this mode, the system displays the communication between the boiler and the control module, the optional interface kit or the optional programmable room thermostat.









Key	Screen	Description of parameters
 MODE		
 STEP		No communication
		Communication between the boiler module and the optional control modules only
		Communication between all the devices connected

FAN MODE [with code]

Key	Screen	Description of parameters
 MODE		Fan speed
 STEP		The current fan speed is 5.500 rpm.

ERROR MODE [with code]

ERROR mode indicates the most recent error, as well as the status of the boiler and its readings at the time this error occurred.

Key	Screen	Description of parameters
 MODE		
 STEP		Code error of the last lock-out
		Status of the boiler at the time of the error
		Start temperature T1 at the time of the error
		Return temperature T2 at the time of the error
		Hot water temperature T3 at the time of the error
		Outdoor temperature T4 at the time of the error

MCBA PARAMETERS FOR THE SPECIALIST

SAFETY STOP [ERROR mode]

If a fault occurs while the appliance is running, the system locks and the screen starts to flash. The first character is an E and the next two characters give the code for this fault, as illustrated in the table below.











To unlock the system:

- Press **RESET** on the screen.
- Contact your installer if the fault happens again.

Codes	Description of the fault	Resolution of the fault
	Abnormal flame signal	<ul style="list-style-type: none"> - Check the wiring (short-circuit in the 24V wiring) - Check the electrode - Replace the MCBA (water damage)
	No flame signal after five attempts at firing the boiler	<ul style="list-style-type: none"> - Check the ignition cable - Check the electrode and the position of the electrode - Check that there is gas at the burner.
	Internal error	If the problem persists after two RESET attempts, replace the MCBA.
	Persistent lock	Press "RESET"
 ↓ 	Internal error	If the problem persists after two RESET attempts, replace the MCBA.
	EPROM error	If the problem persists after two RESET attempts, replace the MCBA.
	Max input, thermostat open or 24V fuse gone.	<ul style="list-style-type: none"> - Check the wiring - Check the 24V fuse on the MCBA. - Shunt12-13 missing
 ↓ 	Internal error	If the problem persists after two RESET attempts, replace the MCBA.
	T1 > 110°C	<ul style="list-style-type: none"> - Check the NTC wiring and replace if necessary. If NTC1 is OK, please verify that the water flows through the boiler.
	T2 > 110°C	<ul style="list-style-type: none"> - Check the NTC wiring and replace if necessary.
	T1 gradient too high	<ul style="list-style-type: none"> - Check that the pump is turning. - If there is no problem with the pump, drain the system.
	No fan signal present	<ul style="list-style-type: none"> - Check the fan control connection - Check the fan wiring If the problem persists after two RESET attempts, replace the MCBA.
	The tachometer signal of the blower does not go to zero.	<ul style="list-style-type: none"> - Check that the convection flow through the chimney is not high enough to rotate the blower. If not, exchange the blower.
	NTC1 short-circuit	<ul style="list-style-type: none"> - Check the connection of the NTC1 sensor - Check the wiring of the NTC1 sensor If the problem persists, replace the NTC1 sensor
	NTC2 short-circuit	<ul style="list-style-type: none"> - Check the connection of the NTC2 sensor - Check the wiring of the NTC2 sensor If the problem persists, replace the NTC2 sensor

MCBA PARAMETERS FOR THE SPECIALIST

Codes	Description of the fault	Resolution of the fault
	NTC3 short-circuit	<ul style="list-style-type: none">- Check the connection of the NTC3 sensor- Check the wiring of the NTC3 sensor If the problem persists, replace the NTC3 sensor
	NTC1 connection open	<ul style="list-style-type: none">- Check the connection of the NTC1 sensor- Check the wiring of the NTC1 sensor If the problem persists, replace the NTC1 sensor
	NTC2 connection open	<ul style="list-style-type: none">- Check the connection of the NTC2 sensor- Check the wiring of the NTC2 sensor If the problem persists, replace the NTC2 sensor
	NTC3 connection open	<ul style="list-style-type: none">- Check the connection of the NTC3 sensor- Check the wiring of the NTC3 sensor If the problem persists, replace the NTC3 sensor
	Internal error	If the problem persists after two RESET attempts, replace the MCBA.
	Flue gas temperature too high (NTC5)	<ul style="list-style-type: none">- Check the connection of the NTC5 sensor- Check the wiring of the NTC5 sensor If the problem persists, replace the NTC5 sensor
	Error while reading the parameters	Press RESET If the error persists, replace the MCBA.
	Problem with the power supply to the fan	<ul style="list-style-type: none">- Check the MCBA power supply voltage. If it is OK, replace the fan.